

José Santiago Vargas,s.a.
maquinaria y ferretería

catálogo de productos **FERRETERÍA 1**

HERRAJES



catálogo de productos FERRETERÍA 1

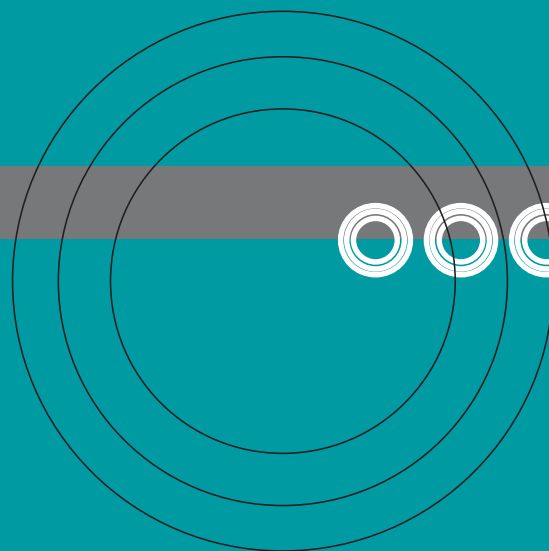



G1

cerrajería

01 cerraduras .1 cerraduras de embutir seguridad	7
01 cerraduras .2 cerraduras de embutir convencionales	11
01 cerraduras .3 cerraduras de sobreponer seguridad	18
01 cerraduras .4 cerraduras de sobreponer convencionales	21
02 cierres eléctricos	25
03 cerrojos	26
04 bombillos	31
05 picaportes	32
06 kit para puerta corredera	35
07 pomos	36

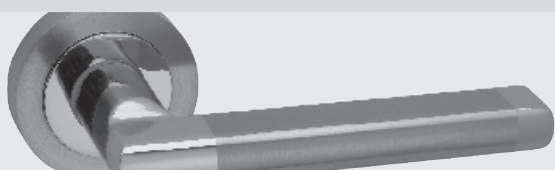

G2

herrajes para obra y decoración

01 manivelas .1 rosetas	41
01 manivelas .2 placas	51
01 manivelas .3 accesorios	61
02 bisagras y pernios	63
03 pomos, manillones y llamadores	67
04 pasadores	70
05 mirillas	73
06 retenedores y topes para puerta	75
07 burletes	77
08 cierrapuertas	78
09 fallebas	78
10 soportes y escuadras	79
11 números	82
12 contramarcos y precercos	83
13 estilo castellano	84



G3

herrajes para el mueble

01 guías correderas y cajones	96
02 bisagras	99
03 compases y pistones	105
04 vaivenes y cierres	106
05 cerraduras	109
06 pasadores	112
07 sistemas de unión	112
08 soporte estantes	116
09 varios	117
10 tiradores	121



G4

sistemas para armarios

01 herrajes de interior	146
02 perfiles de aluminio	148

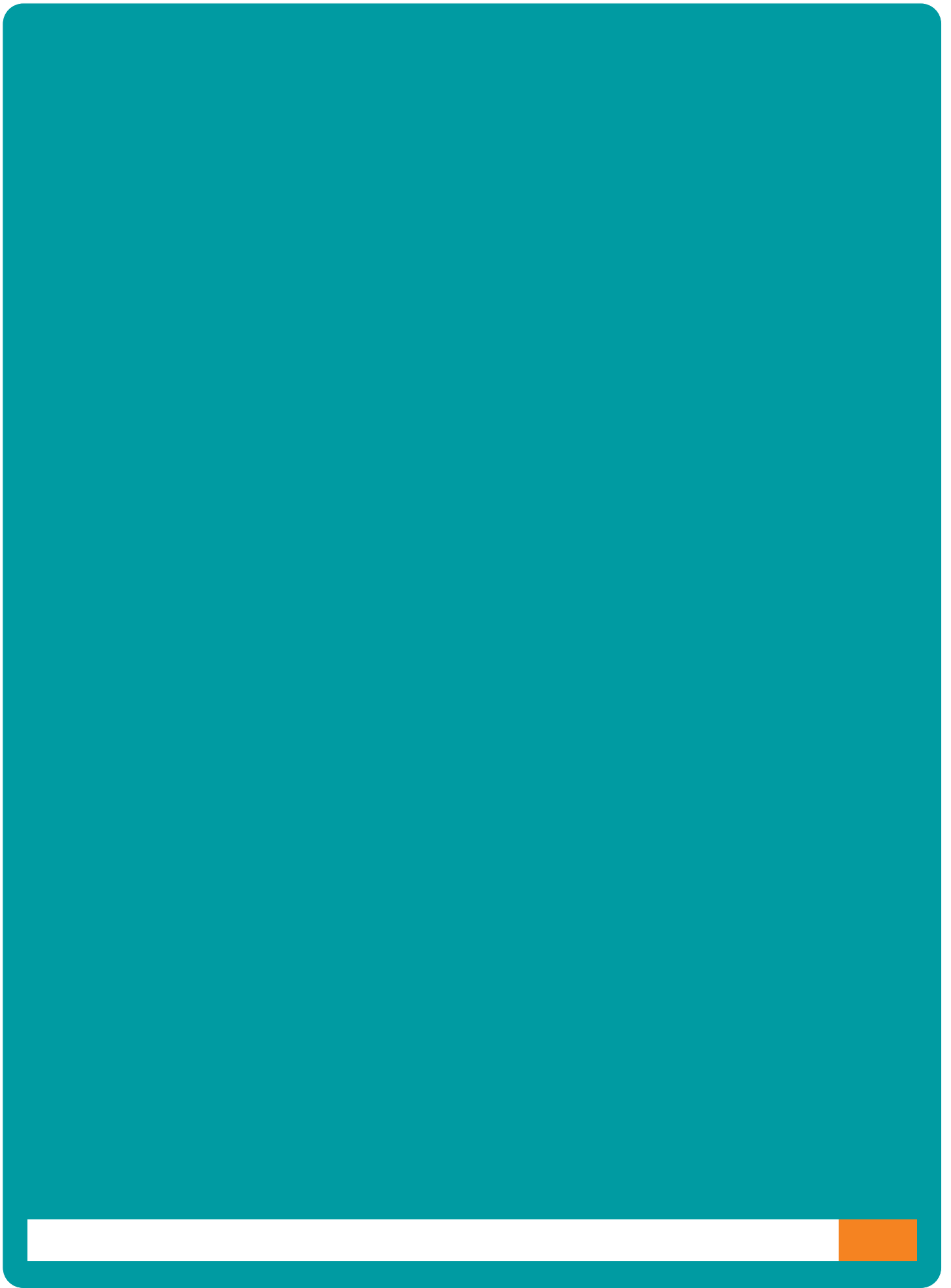

IG1 cerrajería

01 cerraduras .1 cerraduras de embutir seguridad	7
01 cerraduras .2 cerraduras de embutir convencionales	11
01 cerraduras .3 cerraduras de sobreponer seguridad	18
01 cerraduras .4 cerraduras de sobreponer convencionales	21
02 cierres eléctricos	25
03 cerrojos	26
04 bombillos	31
05 picaportes	32
06 kit para puerta corredera	35
07 pomos	36

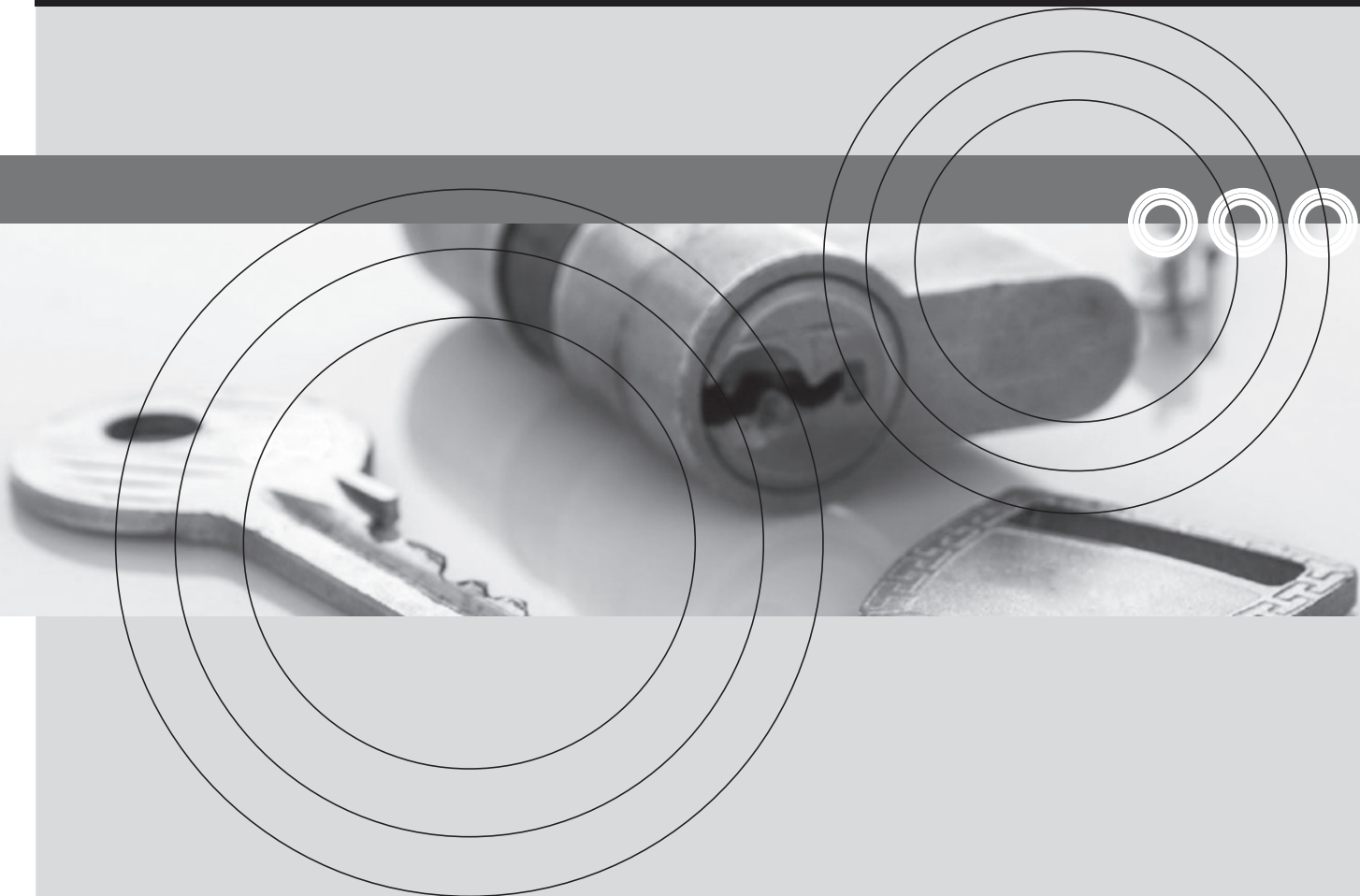

The first part of the document discusses the importance of maintaining accurate records of all transactions. It emphasizes that every entry, no matter how small, should be recorded to ensure the integrity of the financial data. This includes not only sales and purchases but also expenses, income, and transfers between accounts.

The second part of the document provides a detailed breakdown of the accounting cycle. It outlines the ten steps involved in the process, from identifying the accounting entity to preparing financial statements. Each step is explained in detail, with examples provided to illustrate the concepts.

The third part of the document focuses on the classification of accounts. It discusses the different types of accounts, such as assets, liabilities, equity, revenue, and expense accounts, and how they are used to record and summarize business transactions.

The fourth part of the document covers the process of journalizing and posting. It explains how transactions are recorded in the journal and then posted to the ledger accounts. This process is essential for maintaining the double-entry system and ensuring that the books are balanced.

The fifth part of the document discusses the preparation of financial statements. It outlines the steps involved in calculating the net income, preparing the income statement, and determining the ending balances for the assets, liabilities, and equity accounts.

The sixth part of the document covers the process of closing the books. It explains how the temporary accounts (revenue, expense, and dividend accounts) are closed to the permanent accounts (assets, liabilities, and equity accounts) at the end of the accounting period.

The seventh part of the document discusses the importance of adjusting entries. It explains how these entries are used to record accruals, deferrals, and other adjustments that are necessary to ensure that the financial statements are accurate and reflect the true financial position of the business.

The eighth part of the document covers the process of reconciling the books. It explains how the balances in the ledger accounts are compared to the balances in the bank statements and other external records to ensure that they agree.

The ninth part of the document discusses the importance of maintaining accurate records of all transactions. It emphasizes that every entry, no matter how small, should be recorded to ensure the integrity of the financial data. This includes not only sales and purchases but also expenses, income, and transfers between accounts.

The tenth part of the document provides a summary of the key concepts and principles discussed in the document. It emphasizes the importance of accuracy, consistency, and transparency in the accounting process.

01.1 cerraduras / cerraduras de embutir seguridad

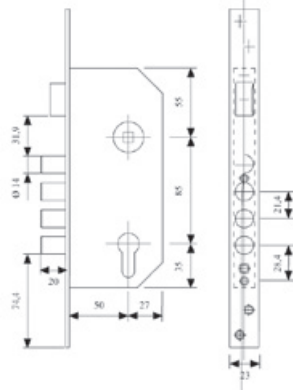

CERRADURA R-100-B

código	descripción
1020002762	R/100/B566E FRENTE ESMALTADO
1020006451	R/100/B666C FRENTE INOX
1020007601	R/10/BR566E FRENTE ESMALTADO CANTO REDONDO

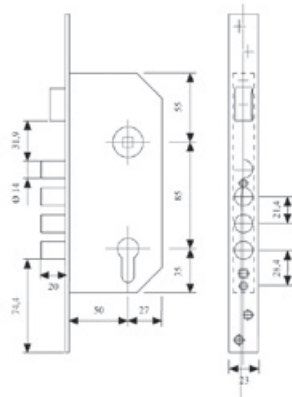

CERRADURA R-200-B

código	descripción
1020002764	R/200/B566L FRENTE LATÓN



medidas
 Entre ejes: 85 mm.
 Entrada: 50 mm.
 Caja: 80x170 mm.



CERRADURA 3350

código	acabado
1020006440	FRENTE INOX
1020006181	FRENTE LATONADO
	NO INCLUYE CILINDRO



medidas
 Entre ejes: 85 mm.
 Entrada: 60 mm.
 Caja: 90x170 mm.



CERRADURA 3360

código	acabado
1020008019	FRENTE INOX
1020006328	FRENTE LATONADO
	NO INCLUYE CILINDRO

**medidas**

Entre ejes: 85 mm.
Entrada: 60 mm.
Caja: 90x170 mm.
Frente: 270x23 mm.

CERRADURA 3240

código	descripción
1020001851	32401-1 FRENTE LATONADO
1020000940	32403-1 FRENTE INOX
1020006988	32405-50 FRENTE NEGRO
1020007553	32408-50 FRENTE BRONCE
1020004627	32401-R-1 FRENTE LATONADO CANTO REDONDO
1020005510	32403-R-1 FRENTE INOX CANTO REDONDO
1020007241	32405-R-50 FRENTE NEGRO CANTO REDONDO
1020007600	32408-R-50 FRENTE BRONCE CANTO REDONDO

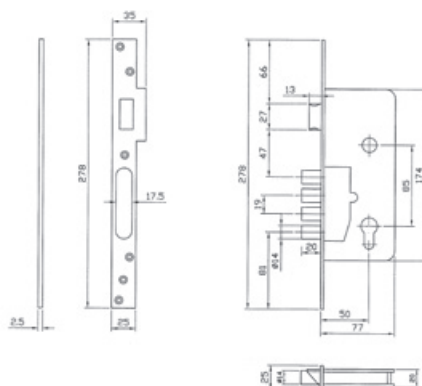
**CERRADURA 700B**

código	acabado
1020007751	FRENTE LATÓN

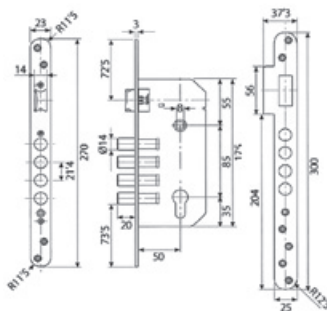
**CERRADURA K408550**

código	acabado
1020008172	CANTO REDONDO FRENTE BRONCE
1020008170	CANTO REDONDO FRENTE LATONADO MATE
1020008171	CANTO REDONDO FRENTE NÍQUEL SATINADO
1020008116	CANTO CUADRADO FRENTE BRONCE
1020008115	CANTO CUADRADO FRENTE LATONADO MATE
1020008114	CANTO CUADRADO FRENTE NÍQUEL SATINADO

**medidas**

Entre ejes: 85 mm.
Entrada: 50 mm.
Caja: 173 mm.
Frente: 22x240 mm.

CERRADURA 280

código	acabado
1020006940	FRENTE BRONCE
1020006939	FRENTE INOX
1020008690	FRENTE LATONADO
1020006941	FRENTE NEGRO
1020006942	FRENTE NÍQUEL CEPILLADO



01.1 cerraduras / cerraduras de embutir seguridad



CERRADURA 220/50

código	acabado
1020009261	FRENTE LATONADO
1020009262	FRENTE NÍQUEL CEPILLADO
	NO INCLUYE CILINDRO

medidas

Entrada: 50 mm.
Caja: 80x100 mm.
Frente: 165x23 mm.

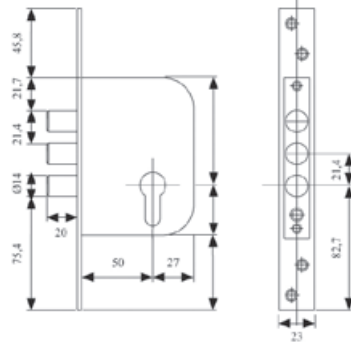

CERRADURA R-101

código	descripción
1020002763	R/101/B566E FRENTE ESMALTADO

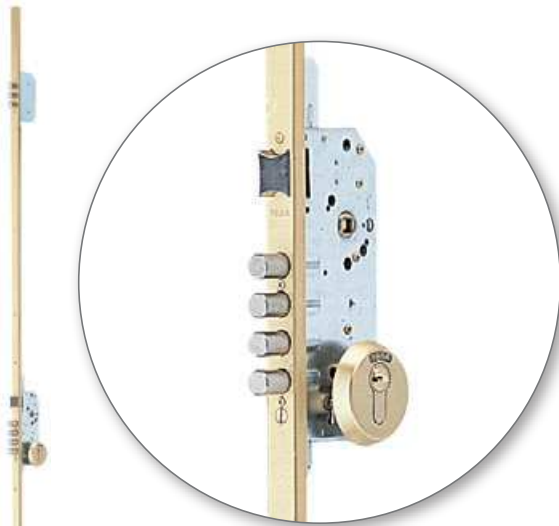

CERRADURA MULTIPUNTO T2B

código	descripción
	3 PUNTOS
1020008235	T2B3566LC CERRADERO LARGO CROMO MATE
1020002767	T2B3566LE CERRADERO LARGO ESMALTADO
	5 PUNTOS
1020002768	T2B5566LE CERRADERO LARGO ESMALTADO

medidas

Entre ejes: 85 mm.
Entrada: 50 mm.
Caja: 77 mm.
Frente: 2030 mm.

**CERRADURA MULTIPUNTO AUTOMÁTICA TAB**

código	descripción
	Cierre automático de los puntos alto y bajo mediante ganchos antipalanca: la puerta queda siempre protegida por los puntos alto y bajo, además de por el picaporte.
1020007770	TAB3566LE CERRADERO LARGO ESMALTADO
1020007769	TAB3566LC CERRADERO LARGO CROMO MATE

**CERRADURA MULTIPUNTO 8922-BS-50**

código	acabado
1020009082	CERRADERO LARGO LATONADA
1020009083	CERRADERO LARGO NIQUEL SATINADO

medidas

Entre ejes: 85 mm.
Entrada: 50 mm.
Caja: 172,5X80 mm.
Frente: 2030 mm.

**CERRADURA MULTIPUNTO 3H**

código	acabado
1020005260	3H004-S54 CERRADERO LARGO NIQUEL
1020005157	3H501-S50 CERRADERO LARGO LATÓN

medidas

Entre ejes: 85 mm.
Entrada: 50 mm.
Caja: 174X80 mm.
Frente: 2030 mm.

**PLACA EMBELLECEDORA PARA ESCUDO**

código	descripción
1020005681	EMBELLECEDOR 10 165x74 mm. CROMO MATE
1020005682	EMBELLECEDOR 10 165x74 mm. CUERO

01.2 cerraduras / cerraduras de embutir convencionales



medidas
 Entre ejes: 85 mm.
 Entrada: 40/50/60/70 mm.
 Caja: 69/74/79/89X175 mm.
 Frente: 23X240 mm.

CERRADURA 2030

código	descripción
1020002757	2030/40 FRENTE LATONADO
1020002758	2030/50 FRENTE LATONADO
1020002759	2030/60 FRENTE LATONADO
1020006413	2030/70 FRENTE LATONADO
1020004447	2030/50 FRENTE INOX
1020005211	2030/60 FRENTE INOX
1020005330	2030/70 FRENTE INOX
1020000328	2030/60 FRENTE NIQUEL SATINADO

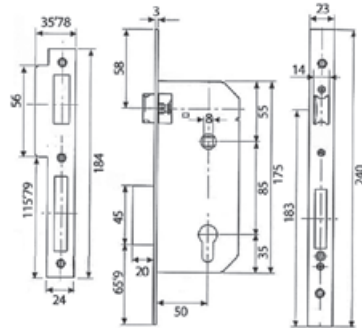

CERRADURA K358550

código	acabado
1020008943	CANTO REDONDO FRENTE LATONADO
1020008832	CANTO REDONDO FRENTE NIQUEL SATINADO



medidas
 Entre ejes: 47 mm.
 Entrada: 35/40/45/50 mm.
 Caja: 62/67/72/77X124 mm.
 Frente: 23X193 mm.

CERRADURA 3100

código	descripción
1020001392	3100 DE 35 FRENTE LATONADO
1020007796	3100 DE 40 FRENTE LATONADO
1020001394	3100 DE 45 FRENTE LATONADO
1020007657	3100 DE 45 FRENTE LATONADO CANTO REDONDO
1020007749	3100 DE 50 FRENTE LATONADO
1020007783	3100 DE 35 FRENTE CROMO MATE
1020007739	3100 DE 40 FRENTE CROMO MATE
1020007688	3100 DE 45 FRENTE CROMO MATE
1020007738	3100 DE 50 FRENTE CROMO MATE
1020008157	3100 DE 45 FRENTE BRONCE



medidas
 Entre ejes: 47 mm.
 Entrada: 40/50/60 mm.
 Caja: 67/77/87X128 mm.
 Frente: 23X196 mm.

CERRADURA 2010-P

código	descripción
1020002750	2010-P/40 FRENTE LATONADO
1020002751	2010-P/50 FRENTE LATONADO
1020006576	2010-P/60 FRENTE LATONADO
	Incluye cilindro TE-5 con 3 llaves.



medidas

Entre ejes: 47,5 mm.
 Entrada: 35/40/50 mm.
 Caja: 62/67/47X195 mm.
 Frente: 23X195 mm.

CERRADURA 5801

código	descripción
1020005973	5801 DE 35 FRENTE LATONADO
1020001845	5801 DE 40 FRENTE LATONADO
1020001846	5801 DE 50 FRENTE LATONADO

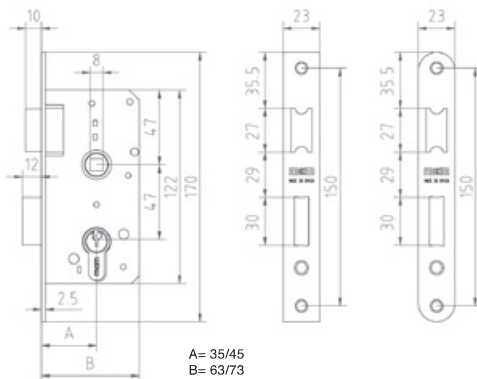

CERRADURA 1501

código	descripción
1020002328	1501/2/35 FRENTE LATONADO
1020002329	1501/2/45 FRENTE LATONADO



medidas

Entre ejes: 47 mm.
 Entrada: 50 mm.
 Caja: 74X195 mm.
 Frente: 22X145 mm.



CERRADURA K304750

código	descripción
1020008604	CANTO REDONDO FRENTE NÍQUEL SATINADO
1020009325	CANTO REDONDO FRENTE LATONADO
1020008358	CANTO CUADRADO FRENTE NÍQUEL SATINADO
1020008357	CANTO CUADRADO FRENTE LATONADO

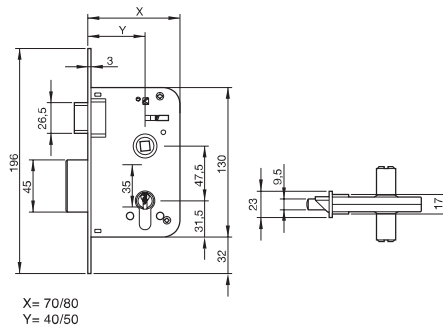

X= 70/80
 Y= 40/50



CERRADURA 600

código	descripción
1020000538	600 70x40 FRENTE LATONADO
1020000539	600 80x50 FRENTE LATONADO

01.2 cerraduras / cerraduras de embutir convencionales



medidas
 Entre ejes: 50 mm.
 Entrada: 40/50 mm.
 Caja: 67/77X128 mm.
 Frente: 23X196 mm.

CERRADURA 2010	
código	descripción
1020002752	2010/40 FRENTE LATONADO
1020002753	2010/50 FRENTE LATONADO



medidas
 Entre ejes: 54,5 mm.
 Entrada: 30/40/50 mm.
 Caja: 29,5/39,5/49,5X120 mm.
 Frente: 20X165 mm.

CERRADURA 2000	
código	descripción
1020002735	2000/30 FRENTE LATONADO
1020002736	2000/40 FRENTE LATONADO
1020002737	2000/50 FRENTE LATONADO

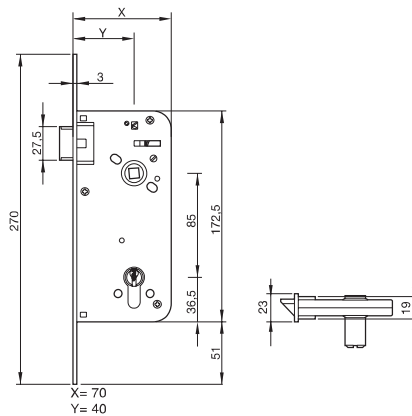

CERRADURA 45	
código	descripción
1020000501	45-70 FL FRENTE LATONADO

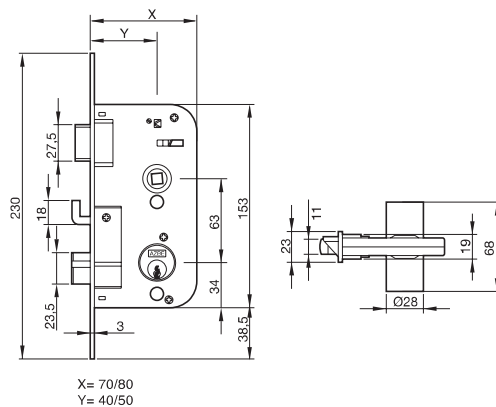

CERRADURA 48	
código	descripción
1020001849	5830 DE 40 FRENTE LATONADO
1020007491	5830 DE 50 FRENTE LATONADO

medidas

Entre ejes: 40/50 mm.
Caja: 67/77X125 mm.
Frente: 23X195 mm.

CERRADURA VAIVÉN 5830

código	descripción
1020001849	5830 DE 40 FRENTE LATONADO
1020007491	5830 DE 50 FRENTE LATONADO

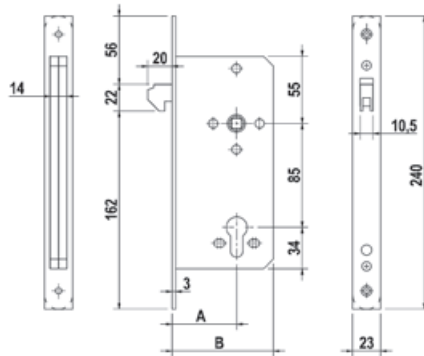

A= 40
B= 67

Ref.: 5440

CERRADURA PARA PUERTA CORREDERA 5440-40

código	descripción
1020001844	5440-40 FRENTE LATONADO

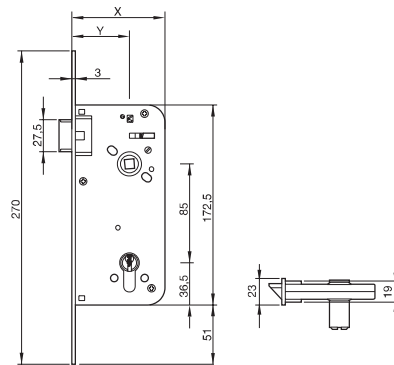

X= 70
Y= 40

CERRADURA PARA PORTERO AUTOMÁTICO 45-E

código	descripción
1020000500	45-E FL FRENTE LATONADO

**medidas**

Entre ejes: 50/60 mm.
Caja: 88 mm.
Frente: 22X140 mm.

CERRADURA CON POMO 1561

código	descripción
1020002345	1561/3/50 FRENTE Y POMO LATONADO
1020002346	1561/3/60 FRENTE Y POMO LATONADO

01.2 cerraduras / cerraduras de embutir convencionales



CERRADURA 2031

código	descripción
1020006910	CERRADURA 2031/40 FREENTE LATONADO
1020003749	CERRADURA 2031/50 FREENTE LATONADO
1020006504	CERRADURA 2031/60 FREENTE LATONADO
1020006938	CERRADURA 2031/40 FREENTE NÍQUEL SATINADO
1020005680	CERRADURA 2031/50 FREENTE NÍQUEL SATINADO
1020005237	CERRADURA 2031/60 FREENTE NÍQUEL SATINADO

medidas

Entre ejes: 40/50/60 mm.
Caja: 69/79/89X96 mm.
Frente: 23X162 mm.

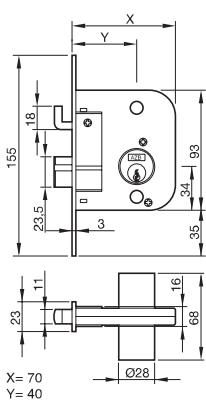

CERRADURA 49

código	descripción
1020000503	49-70 BC FREENTE LATONADO

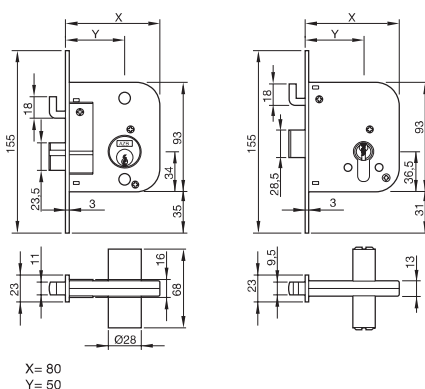

CERRADURA 49-P

código	descripción
1020007002	49P-80 FREENTE LATONADO
1020006501	49P-80 FREENTE NÍQUEL SATINADO



CERRADURA 5811

código	descripción
1020001848	5811 DE 40 FREENTE LATONADO
1020003714	5811 DE 50 FREENTE LATONADO

medidas

Entre ejes: 40/50 mm.
Caja: 67/77x87 mm.
Frente: 23X157 mm.

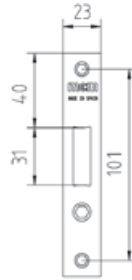
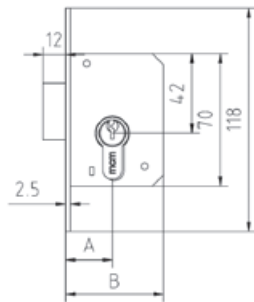

A= 25/35/45
B= 53/63/73

CERRADURA 1512

código	descripción
1020002337	1512/2/25 FRENTE LATONADO
1020002338	1512/2/35 FRENTE LATONADO
1020002339	1512/2/45 FRENTE LATONADO



medidas
Entrada: 30/40/50 mm.
Caja: 29,5/39,5/49,5x72 mm.
Frente: 20X120 mm.



CERRADURA 2001

código	descripción
1020002738	2001/30 FRENTE LATONADO
1020002739	2001/40 FRENTE LATONADO
1020002740	2001/50 FRENTE LATONADO



medidas
Entrada: 40/50 mm.
Caja: 100 mm.
Frente: 22X108 mm.



CERRADURA 233

código	descripción
	NO INCLUYE BOMBILLO
1020008772	233-40 FRENTE LATONADO
1020008770	233-50 FRENTE LATONADO
1020008771	233-40 FRENTE NÍQUEL SATINADO
1020008769	233-50 FRENTE NÍQUEL SATINADO

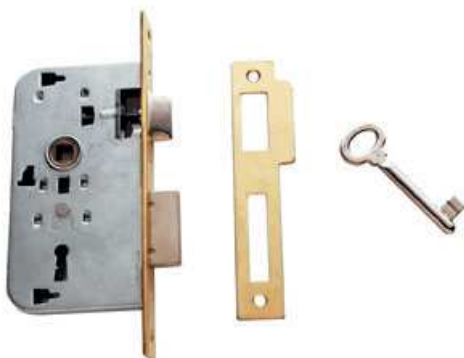

medidas
Entre ejes: 47,5 mm.
Entrada: 30/40/50 mm.
Caja: 54,5/64,5/74,5x74,5 mm.
Frente: 20X165 mm.



CERRADURA LLAVE DE GORJAS 2002

código	descripción
1020002741	2002/30 FRENTE LATONADO
1020002742	2002/40 FRENTE LATONADO
1020002743	2002/50 FRENTE LATONADO

01.2 cerraduras / cerraduras de embutir convencionales

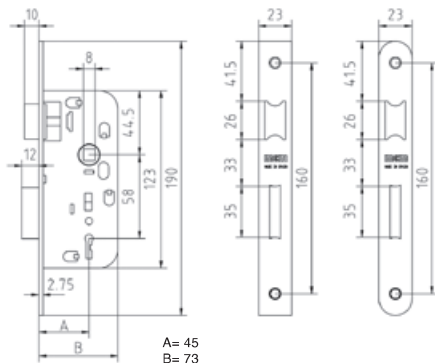

CERRADURA LLAVE DE GORJAS 1508

código	descripción
1020002336	1508/2/45 FRENTE LATONADO



medidas
Entrada: 30/40/50 mm.
Caja: 29,5/39,5/49,5x72 mm.
Frente: 20X120 mm.



CERRADURA LLAVE DE GORJAS 2003

código	descripción
1020002744	2003/30 FRENTE LATONADO
1020002745	2003/40 FRENTE LATONADO
1020002746	2003/50 FRENTE LATONADO



medidas
Entre ejes: 47,5 mm.
Entrada: 40/50/60 mm.
Caja: 67/77/87x128 mm.
Frente: 23X196 mm.



CERRADURA LLAVE DE GORJAS 2004

código	descripción
1020002747	2004/30 FRENTE LATONADO
1020002748	2004/40 FRENTE LATONADO
1020002749	2004/50 FRENTE LATONADO



medidas
Entre ejes: 47,5 mm.
Entrada: 40/50/60 mm.
Caja: 67/77/87x128 mm.
Frente: 23X196 mm.



CERRADURA DE CONDENA 2014

código	descripción
1020002754	2014/40 FRENTE LATONADO
1020002755	2014/50 FRENTE LATONADO
1020002756	2014/60 FRENTE LATONADO

**CERRADURA DE 3 PUNTOS TS-30**

código	descripción
	Bombillo de Seguridad T-60. 3 puntos de anclaje.
1020002778	TS30 T6 ESMALTADO DERECHA
1020002779	TS30 T6 ESMALTADO IZQUIERDA
1020002776	TS30 R6 BOMBILLO REGULABLE ESMALTADO DCHA
1020002777	TS30 R6 BOMBILLO REGULABLE ESMALTADO IZQDA

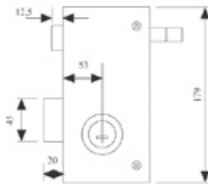
**CERRADURA TS-10**

código	descripción
	Bombillo de Seguridad T-60.
1020003970	TS10-T6 ESMALTADO DERECHA
1020004076	TS10-T6 ESMALTADO IZQUIERDA
1020005488	TS10 R6 BOMBILLO REGULABLE ESMALTADO DERECHA
1020005489	TS10 R6 BOMBILLO REGULABLE ESMALTADO IZQUIERDA
	Bombillo standard TE-5
1020002772	TS10-RE BOMBILLO REGULABLE ESMALTADO DCHA
1020002773	TS10-RE BOMBILLO REGULABLE ESMALTADO IZQDA

**medidas**

Entreda: 36 mm.
Caja: 90x144 mm.

**CERRADURA S-90P**

código	descripción
	Bombillo de Seguridad. Picaporte y cuatro bulones de acero.
1020002454	S-90/P DORADA DERECHA
1020002468	S-90/P DORADA IZQUIERDA
1020002455	S-90/P BOMBILLO 70 DORADA DERECHA
1020002469	S-90/P BOMBILLO 70 DORADA IZQUIERDA

**medidas**

Caja. 88x140 mm.

**CERRADURA 5240**

código	descripción
	Bombillo de Seguridad. Picaporte y cuatro bulones de acero
1020002408	5240 PINTADA DERECHA
1020002421	5240 PINTADA IZQUIERDA

01.3 cerraduras / cerraduras de sobreponer seguridad

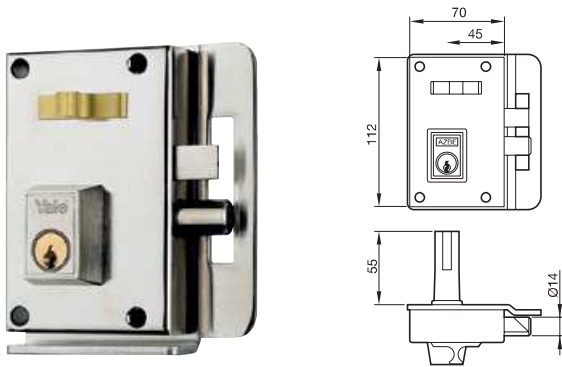

CERRADURA 10

código	descripción
	Bombillo standard. Picaporte y un bulón de acero.
1020003433	CERRADURA 10 DE 70 NÍQUEL DERECHA
1020003434	CERRADURA 10 DE 70 NÍQUEL IZQUIERDA



medidas
143x115 mm.

CERRADURA 231 Y 229

código	descripción
	Bombillo standard. Picaporte y tres bulones de acero. Bombillo fijo de 52 mm.
1020002399	231 PINTADO DERECHA
1020002412	231 PINTADO IZQUIERDA
	Bombillo standard. Picaporte y tres bulones de acero. Bombillo regulable de 35 a 80 mm.
1020002398	229 BOMBILLO GRADUABLE PINTADO DERECHA
1020002411	229 BOMBILLO GRADUABLE PINTADO IZQUIERDA



medidas
70x110 mm.

CERRADURA 234

código	descripción
	Bombillo standard. Picaporte y cuatro bulones de acero. Bombillo fijo de 52 mm.
1020002401	234 PINTADO DERECHA
1020002414	234 PINTADO IZQUIERDA



medidas
88x140 mm.

CERRADURA 240

código	descripción
	Bombillo standard. Picaporte y cuatro bulones de acero. Bombillo fijo de 52 mm.
1020002403	240 PINTADO DERECHA
1020002416	240 PINTADO IZQUIERDA
1020008925	240 CROMADO MATE DERECHA
1020008926	240 CROMADO MATE IZQUIERDA
	Bombillo standard. Picaporte y cuatro bulones de acero. Bombillo regulable de 35 a 80 mm.
1020002405	243 BOMBILLO GRADUABLE PINTADO DERECHA
1020002418	243 BOMBILLO GRADUABLE PINTADO IZQUIERDA



medidas
Entradas: 36 mm.
Caja: 90x144 mm.

CERRADURA S-90C-P

código	descripción
	Bombillo de Seguridad. Cinco bulones de acero.
1020002453	S-90C/P DORADA DERECHA
1020002467	S-90C/P DORADA IZQUIERDA
1020002452	S-90C/P BOMBILLO 70 DORADA DERECHA
1020002466	S-90C/P BOMBILLO 70 DORADA IZQUIERDA



medidas
Caja: 88x140 mm.

CERRADURA 2239

código	descripción
	Bombillo de Seguridad. Cinco bulones de acero.
1020002407	5239 PINTADA DERECHA
1020002420	5239 PINTADA IZQUIERDA



medidas
Caja: 143x115 mm.

CERRADURA 228

código	acabado
	Bombillo standard. Cuatro bulones de acero. Bombillo regulable de 35 a 80 mm.
1020002397	228 PINTADA DERECHA
1020002410	228 PINTADA IZQUIERDA



medidas
Caja: 70x110 mm.

CERRADURA 233

código	descripción
	Bombillo standard. Cinco bulones de acero. Bombillo fijo de 52 mm.
1020002400	233 PINTADA DERECHA
1020002413	233 PINTADA IZQUIERDA

01.3 cerraduras / cerraduras de sobreponer seguridad



medidas
Caja: 88x140 mm.

CERRADURA 239 Y 242

código	descripción
	Bombillo standard. Cinco bulones de acero. Bombillo fijo de 52 mm.
1020002402	239 PINTADA DERECHA
1020002415	239 PINTADA IZQUIERDA
	Bombillo standard. Cinco bulones de acero. Bombillo regulable de 35 a 80 mm.
1020002404	242 BOMBILLO GRADUABLE PINTADO DERECHA
1020002417	242 BOMBILLO GRADUABLE PINTADO IZQUIERDA

01.4 cerraduras / cerraduras de sobreponer convencionales



CERRADURA 33

código	descripción
	Dos vueltas de pestillo.
1020008030	33 DE 60 PINTADO ORO DERECHA
1020008057	33 DE 60 PINTADO ORO IZQUIERDA



CERRADURA 34

código	descripción
	Con picaporte y dos vueltas de pestillo.
1020008031	34 DE 60 PINTADO ORO DERECHA
1020008032	34 DE 60 PINTADO ORO IZQUIERDA
1020007969	34 DE 70 PINTADO ORO DERECHA
1020008626	34 DE 70 PINTADO ORO IZQUIERDA



CERRADURA 35

código	descripción
	Con picaporte accionado por manilla y dos vueltas de pestillo.
1020008125	35 DE 60 PINTADO ORO DERECHA
1020008156	35 DE 60 PINTADO ORO IZQUIERDA



CERRADURA 12

código	descripción
	Con picaporte y dos vueltas de pestillo.
1020007970	12 DE 80 PINTADO ORO DERECHA
1020008059	12 DE 80 PINTADO ORO IZQUIERDA
1020008226	12 DE 80 BOMBILLO DE 70 PINTADO ORO DERECHA
1020008586	12 DE 80 BOMBILLO DE 70 PINTADO ORO IZQUIERDA
1020008060	12 DE 100 PINTADO ORO DERECHA
1020008061	12 DE 100 PINTADO ORO IZQUIERDA
1020008146	12 DE 100 BOMBILLO DE 70 PINTADO ORO DERECHA
1020008176	12 DE 100 BOMBILLO DE 70 PINTADO ORO IZQUIERDA
1020008035	12 DE 120 PINTADO ORO DERECHA
1020008039	12 DE 120 PINTADO ORO IZQUIERDA
1020008177	12 DE 120 BOMBILLO DE 70 PINTADO ORO DERECHA
1020008178	12 DE 120 BOMBILLO DE 70 PINTADO ORO IZQUIERDA



CERRADURA 11

código	descripción
	Dos vueltas de pestillo.
1020008126	11 DE 80 PINTADO ORO DERECHA
1020008033	11 DE 80 PINTADO ORO IZQUIERDA
1020008513	11 DE 80 BOMBILLO DE 70 PINTADO ORO DERECHA
1020008569	11 DE 80 BOMBILLO DE 70 PINTADO ORO IZQUIERDA
1020008096	11 DE 100 PINTADO ORO DERECHA
1020008058	11 DE 100 PINTADO ORO IZQUIERDA
1020008144	11 DE 100 BOMBILLO DE 70 PINTADO ORO DERECHA
1020008145	11 DE 100 BOMBILLO DE 70 PINTADO ORO IZQUIERDA
1020008034	11 DE 120 PINTADO ORO DERECHA
1020008599	11 DE 120 PINTADO ORO IZQUIERDA
1020008225	11 DE 120 BOMBILLO DE 70 PINTADO ORO DERECHA
1020008764	11 DE 120 BOMBILLO DE 70 PINTADO ORO IZQUIERDA

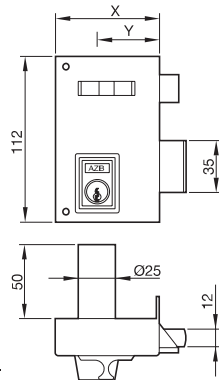

X= 60 mm.
Y= 35 mm.



CERRADURA 56-A

código	descripción
1020000521	56-A DE 60 NIQUELADA DERECHA
1020000504	56-A DE 60 NIQUELADA IZQUIERDA
1020000522	56-A DE 60 PINTADA DERECHA
1020000505	56-A DE 60 PINTADA IZQUIERDA

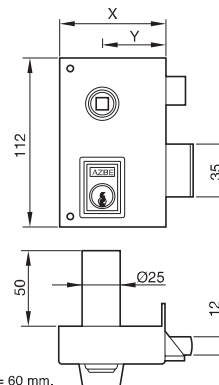

X= 60 mm.
Y= 35 mm.



CERRADURA 56-B

código	descripción
1020000523	56-B DE 60 NIQUELADA DERECHA
1020000506	56-B DE 60 NIQUELADA IZQUIERDA
1020000524	56-B DE 60 PINTADA DERECHA
1020000507	56-B DE 60 PINTADA IZQUIERDA

01.4 cerraduras / cerraduras de sobreponer convencionales

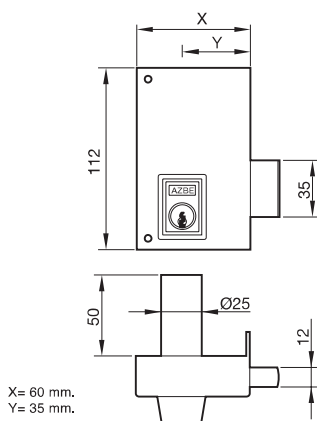

CERRADURA 56-C

código	descripción
1020000525	56-C DE 60 NIQUELADA DERECHA
1020000508	56-C DE 60 NIQUELADA IZQUIERDA
1020000526	56-C DE 60 PINTADA DERECHA
1020000509	56-C DE 60 PINTADA IZQUIERDA



X = 80; 100; 120 mm.
Y = 48; 50, 60 mm.

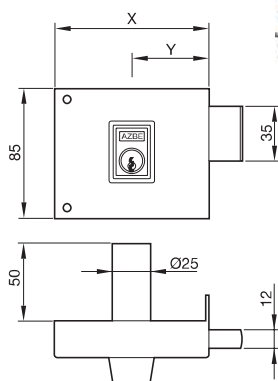

CERRADURA 124

código	descripción
1020000527	124 DE 8 NIQUELADA DERECHA
1020000510	124 DE 8 NIQUELADA IZQUIERDA
1020000529	124 DE 8 PINTADA DERECHA
1020000512	124 DE 8 PINTADA IZQUIERDA
1020000528	124 DE 10 NIQUELADA DERECHA
1020000511	124 DE 10 NIQUELADA IZQUIERDA
1020000530	124 DE 10 PINTADA DERECHA
1020000513	124 DE 10 PINTADA IZQUIERDA
1020000531	124 DE 12 PINTADA DERECHA
1020000514	124 DE 12 PINTADA IZQUIERDA



X = 80; 100; 120 mm.
Y = 48; 50, 60 mm.

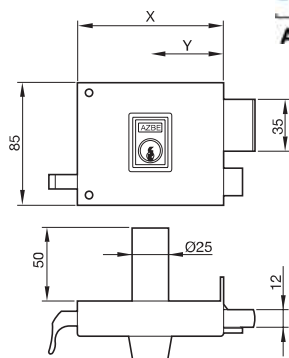

CERRADURA 125

código	descripción
1020003432	125 DE 8 NIQUELADA DERECHA
1020003431	125 DE 8 NIQUELADA IZQUIERDA
1020000533	125 DE 8 PINTADA DERECHA
1020000516	125 DE 8 PINTADA IZQUIERDA
1020000532	125 DE 10 NIQUELADA DERECHA
1020000515	125 DE 10 NIQUELADA IZQUIERDA
1020000534	125 DE 10 PINTADA DERECHA
1020000517	125 DE 10 PINTADA IZQUIERDA
1020000537	125 DE 12 NIQUELADA DERECHA
1020000520	125 DE 12 NIQUELADA IZQUIERDA
1020000535	125 DE 12 PINTADA DERECHA
1020000518	125 DE 12 PINTADA IZQUIERDA



CERRADURA 15

código	acabado
1020000947	15 DE 50 DERECHA
1020000950	15 DE 50 IZQUIERDA



CERRADURA 47-A

código	descripción
1020000948	47-A DE 50 DERECHA
1020000951	47-A DE 50 IZQUIERDA
1020000949	47-A DE 60 DERECHA
1020000952	47-A DE 60 IZQUIERDA



CERRADURA 71-B

código	descripción
1020003763	71-B DE 3" DERECHA
1020000958	71-B DE 3" IZQUIERDA
1020000955	71-B DE 4" DERECHA
1020000959	71-B DE 4" IZQUIERDA
1020000956	71-B DE 5" DERECHA
1020000960	71-B DE 5" IZQUIERDA
1020000957	71-B DE 6" DERECHA
1020000961	71-B DE 6" IZQUIERDA

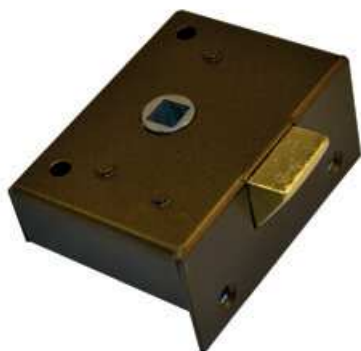

Picaporte 234

código	medidas
1020003454	50 mm.
1020003453	60 mm.

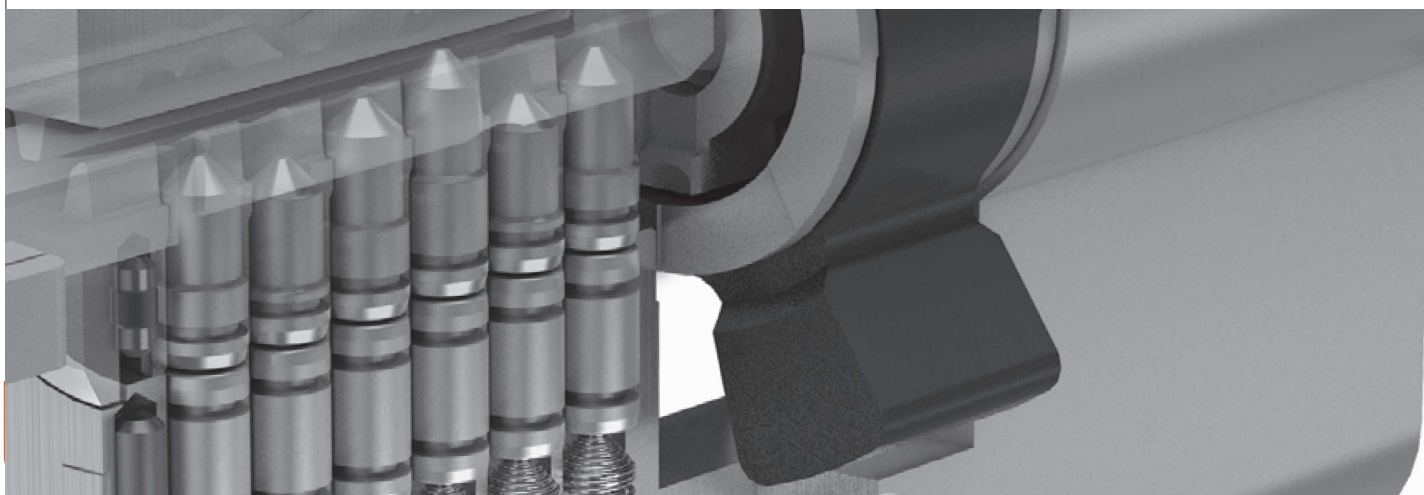

02 cierres eléctricos

CIERRE ELÉCTRICO 1740/907

código	descripción
	Reversible. Pestillo regulable. Al recibir impulso eléctrico queda desbloqueado para una apertura.
1020007761	1740/907 T DC DORADO (Corriente continua, video portero)
1020002424	1740/907 T DORADO (Corriente alterna)
1020007637	1740/907 X DC INOX (Corriente continua, video portero)
1020005930	1740/907 X INOX (Corriente alterna)

CIERRE ELÉCTRICO 54-ADF DORCAS

código	descripción
	Al recibir impulso eléctrico queda desbloqueado para una apertura.
1020007705	54-ADF CUERO
1020008152	54-ADF INOX
1020008151	54-ADF LATONADO
1020007704	54-ADF NEGRO
1020000511	124 DE 10 NIQUELADA IZQUIERDA

CIERRE ELÉCTRICO 54-ABDF DORCAS

código	descripción
1020008866	54-ABDF SIN FRONTAL

CIERRE ELÉCTRICO 1035

código	descripción
	Al recibir impulso eléctrico queda desbloqueado para una apertura.
1020008851	1035 DERECHA PINTADO GRIS
1020009486	1035 IZQUIERDA PINTADO GRIS



CIERRE ELÉCTRICO 1037

código	descripción
	Al recibir impulso eléctrico queda desbloqueado para una apertura.
1020002409	1037 DERECHA PINTADO GRIS
1020002422	1037 IZQUIERDA PINTADO GRIS



ABREPUERTAS DORCAS

código	descripción
1020008634	ABREPUERTA HORIZONTAL REVERSIBLE ORO
1020008635	ABREPUERTA VERTICAL REVERSIBLE ORO

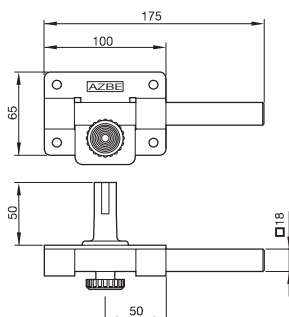

CERROJOS 5

código	descripción
1020000550	5 NIQUELADO
1020000551	5 PINTADO

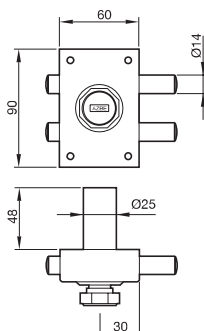

CERROJOS 16

código	descripción
1020000498	16 NIQUELADO
1020000499	16 PINTADO

03 cerrojos

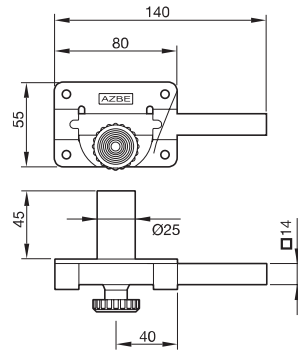

CERROJO 18

código	descripción
1020000552	18 NIQUELADO
1020000553	18 PINTADO

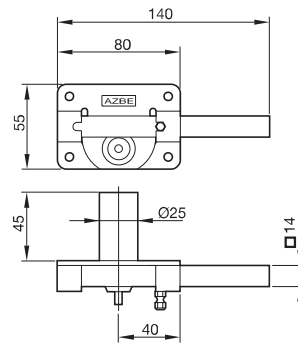

CERROJO 19

código	descripción
1020000554	19 NIQUELADO
1020000555	19 PINTADO



medidas
105x87 mm.



CERRADURA 101-R/105

código	descripción
	Bombillo redondo.
1020002474	101-R/105 PINTADO
1020002475	101-R/105 PINTADO BOMBILLO DE 70
1020007835	101-R/105 NÍQUEL BOMBILLO DE 70



medidas
85x82 mm.



CERRADURA 201-R/80

código	descripción
	Bombillo redondo.
1020002480	201-R/80 NÍQUEL
1020002481	201-R/80 NÍQUEL BOMBILLO DE 70
1020002478	201-R/80 DORADO
1020002479	201-R/80 DORADO BOMBILLO DE 70



medidas
87x75 mm.

CERROJO 300-R/80

código	descripcion
	Bombillo de pera.
1020002482	300-R/80 NIQUEL



medidas
85x83 mm./ 120x80 mm.

CERROJO 301-R

código	descripcion
	Bombillo de pera
1020002489	301-R/80 DORADO
1020002490	301-R/80 NIQUEL
1020002491	301-R/80 NIQUEL BOMBILLO DE 80
1020003908	301-R/80 NIQUEL BOMBILLO DE 90
1020007081	301-R/120 DORADO
1020005242	301-R/120 DORADO BOMBILLO DE 70
1020002492	301-R/120 NIQUEL
1020002493	301-R/120 NIQUEL BOMBILLO DE 70
1020003729	301-R/120 NIQUEL BOMBILLO DE 90



medidas
85x83 mm.

CERROJO DE SEGURIDAD 301-RP/80

código	descripcion
	Llave de seguridad de 6 puntos. Bombillo.
1020002494	301-RP/80 DORADO
1020002495	301-RP/80 DORADO BOMBILLO DE 70
1020002496	301-RP/80 NIQUEL BOMBILLO DE 70



medidas
85x83 mm.

CERROJO 305-R/80

código	descripcion
	Con resbalón.
1020002497	305-R/80 NIQUEL DERECHA
1020002503	305-R/80 NIQUEL IZQUIERDA
1020002498	305-R/80 NIQUEL BOMBILLO DE 70 DERECHA
1020002504	305-R/80 NIQUEL BOMBILLO DE 70 IZQUIERDA

03 cerrojos

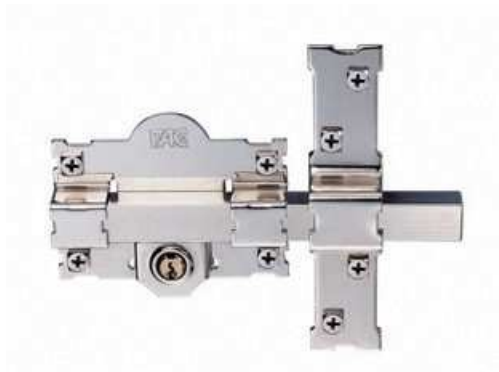

medidas
105x87 mm.

CERROJO 101-L/105

código	descripción
	Llave a las dos caras. Bombillo redondo
1020002472	101-L/105 PINTADO
1020002473	101-L/105 PINTADO BOMBILLO DE 70



medidas
85x82 mm.



CERROJO 201-L /80

código	descripción
	Llave a las dos caras. Bombillo redondo.
1020002476	201-L/80 NIQUEL FAC
1020002477	201-L/80 NIQUEL BOMBILLO DE 70



medidas
120x80 mm.



CERROJO 301-L

código	descripción
	Llave a las dos caras. Bombillo de pera.
1020002485	301-L/80 NIQUEL
1020002486	301-L/80 NIQUEL BOMBILLO DE 70
1020002487	301-L/120 NIQUEL
1020002488	301-L/120 NIQUEL BOMBILLO DE 70
1020003437	301-L/120 DORADO BOMBILLO DE 70



medidas
115x90 mm.



CERROJO 306-L/115

código	descripción
	Llave a las dos caras. Con resbalón. Bombillo de pera.
1020002500	306-L/115 NIQUEL BOMBILLO DE 70 DERECHA
1020002506	306-L/115 NIQUEL BOMBILLO DE 70 IZQUIERDA
1020002499	306-L/115 NIQUEL DERECHA
1020002505	306-L/115 NIQUEL IZQUIERDA

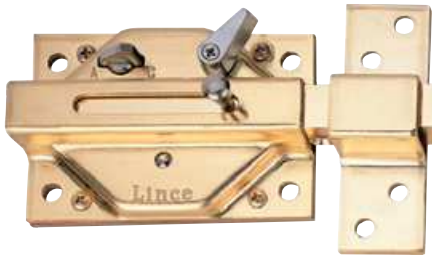
CERROJO 3930

código	descripción
1020007478	3930 BRONCE INGLÉS
1020007473	3930 BRONCE INGLÉS BOMBILLO DE 70
1020007477	3930 CROMO
1020007475	3930 CROMO BOMBILLO DE 70
1020007476	3930 LATONADO
1020007474	3930 LATONADO BOMBILLO DE 70

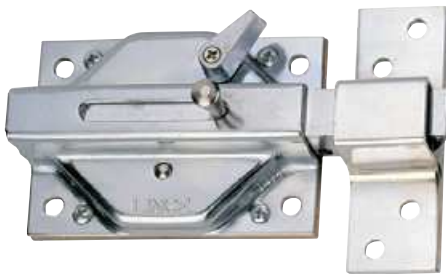
CERROJO 3935

código	descripción
	Con resbalón.
1020001859	3935 CROMO DERECHA
1020001855	3935 CROMO IZQUIERDA
1020001860	3935 LATONADO DERECHA
1020001856	3935 LATONADO IZQUIERDA
1020001861	3935 BOMBILLO DE 70 LATONADO DERECHA
1020001857	3935 BOMBILLO DE 70 LATONADO IZQUIERDA

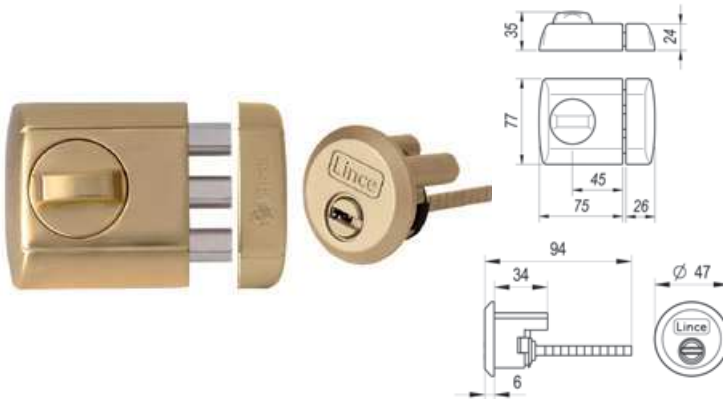

CERROJO DE ALTA SEGURIDAD 4930

código	descripción
	Con bombillo C-3 y llave de seguridad multipunto.
1020008780	SUPRA 4930 NÍQUEL SATINADO
1020008777	SUPRA 4930 LATONADO MATE

CERROJO DE ALTA SEGURIDAD 4940

código	descripción
	Sin bombillo.
1020008779	SUPRA 4940 SIMPLY NÍQUEL SATINADO
1020008778	SUPRA 4940 SIMPLY LATONADO MATE

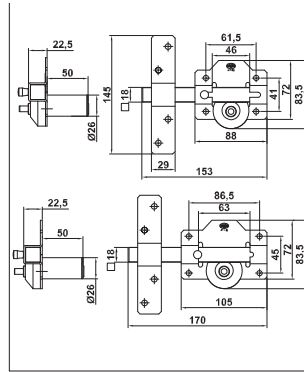
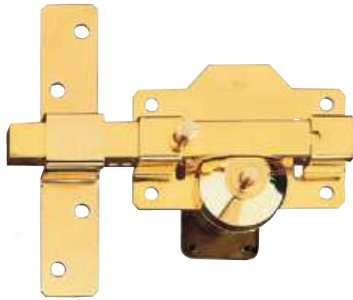
03 cerrojos



CERROJO DE SEGURIDAD 1 y 3

código	descripción
	Con llave de seguridad multipunto.
1020003898	1-88x153 DORADO
1020003899	1-105x170 DORADO
1020005161	3-88x153 BOMBILLO DE 70 DORADO
1020005160	3-105x170 BOMBILLO DE 70 DORADO

cerrajería 04

04 bombillos



BOMBILLO DE SEGURIDAD AS6/DE

código	descripción
Cilindro de seguridad "doble embrague" con 6 pitones Se suministra con 5 llaves planas reversibles. Europerfil con excéntrica de 15 mm. Protección anti-taladro tanto en el cañón, como en el tambor.	
1020008743	AS6DE 30+30 LATÓN
1020008745	AS6DE 35+35 LATÓN
1020008747	AS6DE 40+30 LATÓN
1020008811	AS6DE 40+40 LATÓN
1020008894	AS6DE 45+35 LATÓN
1020008892	AS6DE 45+45 LATÓN
1020008749	AS6DE 50+30 LATÓN
1020008736	AS6DE 50+40 LATÓN

1020008751	AS6DE 50+50 LATÓN
1020008752	AS6DE 60+30 LATÓN
1020008741	AS6DE 60+40 LATÓN
1020008898	AS6DE 70+30 LATÓN
1020008744	AS6DE 30+30 NÍQUEL
1020008746	AS6DE 35+35 NÍQUEL
1020008748	AS6DE 40+30 NÍQUEL
1020008742	AS6DE 40+40 NÍQUEL
1020008896	AS6DE 45+35 NÍQUEL
1020008893	AS6DE 45+45 NÍQUEL
1020008750	AS6DE 50+30 NÍQUEL
1020008737	AS6DE 50+40 NÍQUEL
1020008753	AS6DE 60+30 NÍQUEL
1020008754	AS6DE 60+40 NÍQUEL



BOMBILLO DE SEGURIDAD KE

código	descripción
Cilindro de seguridad de latón con 6 pitones. Se suministra con 5 llaves planas reversibles.	
1020008117	KE-2006 30+30 LATÓN
1020008119	KE-2007 35+35 LATÓN
1020008118	KE-2007 40+30 LATÓN
1020008529	KE-2008 40+40 LATÓN
1020008099	KE-2008 50+30 LATÓN
1020008120	KE-2009 50+40 LATÓN
1020008121	KE-20010 60+40 LATÓN
1020008027	KE-2006 30+30 NÍQUEL
1020008148	KE-2007 35+35 NÍQUEL
1020008083	KE-2007 40+30 NÍQUEL
1020008525	KE-2008 40+40 NÍQUEL
1020008084	KE-2008 50+30 NÍQUEL
1020008028	KE-2009 50+40 NÍQUEL
1020008085	KE-20010 60+40 NÍQUEL

**PICAPORTE 6**

código	descripción
1020000351	6 DE 35 LATONADO
1020000352	6 DE 45 LATONADO
1020006466	6 DE 45 CUERO
1020006467	6 DE 45 NEGRO
1020006465	6 DE 45 INOX
1020000363	6 DE 45 NÍQUEL

**PICAPORTE 8**

código	descripción
1020000355	8 DE 45 LATONADO
1020006472	8 DE 45 CUERO
1020006473	8 DE 45 NEGRO
1020006471	8 DE 45 INOX
1020000365	8 DE 45 NÍQUEL
1020000356	8 DE 45 ESPECIAL MÁQUINA LATONADO

**PICAPORTE 12**

código	descripción
1020000358	12 DE 45 LATONADO
1020008909	12 DE 45 NÍQUEL
1020000359	12 DE 60 LATONADO
1020008884	12 DE 60 NÍQUEL
1020000360	12 DE 70 LATONADO
1020009181	12 DE 70 NÍQUEL

**PICAPORTE 7**

código	descripción
1020000353	7 DE 60 LATONADO
1020006469	7 DE 60 CUERO
1020006470	7 DE 60 NEGRO
1020006468	7 DE 60 INOX
1020000364	7 DE 60 NÍQUEL
1020000354	7 DE 70 LATONADO
1020005919	7 DE 70 NÍQUEL

05 picaportes

PICAPORTE UNIFICADO 47 mm.

código	descripción
	Medidas: 47 mm. entre puntos; 50 mm. al centro.
1020009269	LATONADO
1020009148	NEGRO
1020009140	CUERO
1020009147	NÍQUEL SATINADO

**PICAPORTE UNIFICADO 70 mm.
(Desplazado con antipánico)**

código	descripción
	Medidas: 70 mm. entre puntos; 50 mm. al centro.
1020008639	710-HPR NÍQUEL SATINADO
1020008638	720-HPR BRONCE

PICAPORTE 2000

código	descripción
	Medidas: 47 mm. entre puntos; 50 mm. al centro.
1020000366	2000 LATONADO
1020000349	2000 NEGRO
1020000350	2000 NÍQUEL
1020007664	2001 CUERO

PICAPORTE 2100

código	descripción
	Medidas: 47 mm. entre puntos; 50 mm. al centro.
1020000347	2100 LATONADO
1020000348	2100 NEGRO
1020000367	2100 NÍQUEL



PICAPORTE 4000

código	descripción
	Medidas: 70 mm. entre puntos; 50 mm. al centro.
1020005663	4000 LATONADO
1020007118	4000 NEGRO
1020005748	4000 CROMO MATE
1020007117	4000 CUERO



PICAPORTE 4100

código	descripción
	Medidas: 70 mm entre puntos; 50 mm. al centro.
1020005662	4100 LATONADO
1020005573	4100 CROMO MATE



PICAPORTE 2005

código	descripción
1020002791	2005/30 LATONADO
1020002792	2005/40 LATONADO
1020002793	2005/50 LATONADO



PICAPORTE 2015

código	descripción
1020002797	2015/40 LATONADO
1020002798	2015/50 LATONADO
1020002799	2015/60 LATONADO

05 picaportes



PICAPORTE 1510

código	descripción
1020002353	1510/2/35 LATONADO
1020002354	1510/2/45 LATONADO
1020002355	1510/2/50 LATONADO
1020002356	1510/2/60 LATONADO



PICAPORTE MAGNÉTICO 826

código	acabado
1020008388	CROMO SATINADO



PICAPORTE VAIVÉN 818

código	acabado
1020009553	NÍQUEL SATINADO

06 Kit para puerta corredera



KIT CAZOLETA PARA PUERTA CORREDERA

código	descripción
1020007591	168HP LATONADO
1020007590	167HP NÍQUEL SATINADO
1020007592	169HP BRONCE
1020007593	173HP CROMO SATINADO



KIT CAZOLETA CUADRADA PARA PUERTA CORREDERA

código	descripción
1020008620	198HP CUADRADO NÍQUEL SATINADO

Kit para puerta corredera 06



KIT PARA PUERTA CORREDERA

código	descripción
	Incluye: picaporte, muletilla, desbloqueo y dedal.
1020007606	163HP LATONADO
1020007587	164HP NÍQUEL SATINADO
1020007588	165HP BRONCE
1020007589	166HP CROMO SATINADO



KIT PARA PUERTA CORREDERA CUADRADO

código	descripción
	Incluye: picaporte, muletilla, desbloqueo y dedal.
1020008621	197HP CUADRADO NÍQUEL SATINADO

pomos 07



POMO SERIE 600

código	descripción
1020007776	ENTRADA 600 60/70 LATÓN MATE
1020007777	PASO 601 60/70 LATÓN MATE
1020007778	PRIVADO 602 60/70 LATÓN MATE
1020007779	CON LLAVE 603 60/70 C/LLAVE LATÓN MATE



POMO SERIE 610

código	descripción
1020007899	ENTRADA 610 60/70 CROMO MATE
1020008160	ENTRADA 610 60/70 LATÓN PULIDO
1020007831	PASO 611 60/70 CROMO MATE
1020008161	PASO 611 60/70 LATÓN PULIDO
1020007847	PRIVADO 612 60/70 CROMO MATE
1020008162	PRIVADO 612 60/70 LATÓN PULIDO
1020007848	CON LLAVE 613 60/70 CROMO MATE
1020008163	CON LLAVE 613 60/70 LATÓN PULIDO





IG2

herrajes para obra y decoración

01 manivelas .1 rosetas	41
01 manivelas .2 placas	51
01 manivelas .3 accesorios	61
02 bisagras y pernios	63
03 pomos, manillones y llamadores	67
04 pasadores	70
05 mirillas	73
06 retenedores y topes para puerta	75
07 burletes	77
08 cierrapuertas	78
09 fallebas	78
10 soportes y escuadras	79
11 números	82
12 contramarcos y precercos	83
13 estilo castellano	84

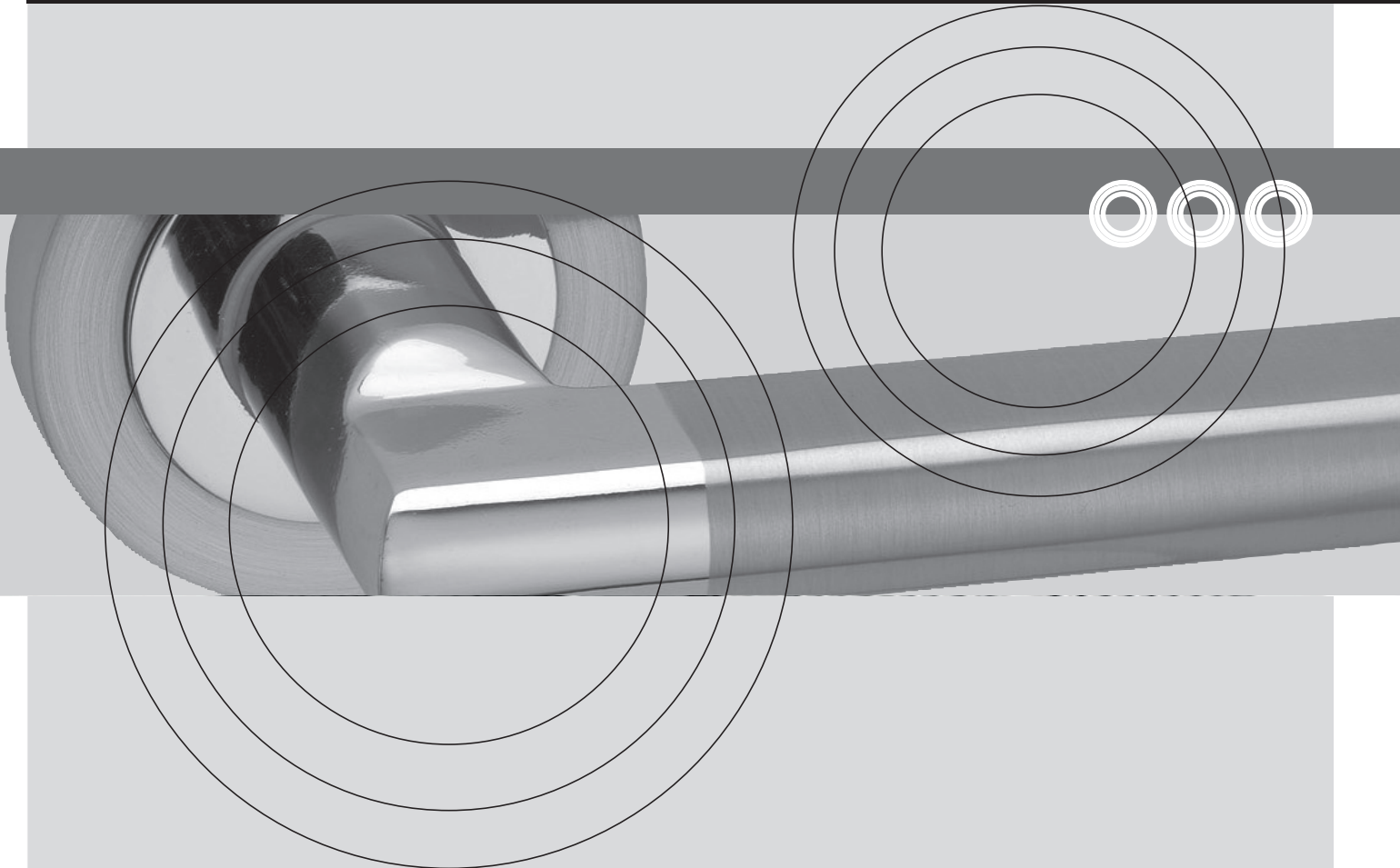



01.1 manivelas / rosetas



Mod. D-115	
código	acabado
1020009526	Níquel satinado



Mod. D-110	
código	acabado
1020009527	Níquel satinado



Mod. D-150	
código	acabado
1020009528	Níquel satinado / cromo brillo



Mod. D-130	
código	acabado
1020009529	Níquel satinado



Mod. D-92	
código	acabado
1020009529	Níquel satinado / cromo brillo



Mod. P-9631	
código	acabado
1020009468	Níquel satinado / cromo brillo



Mod. P-9633	
código	acabado
1020009469	Níquel satinado / cromo brillo



ATENAS D-20	
código	acabado
1020008820	Níquel satinado / cromo brillo



Mod. LISBOA D-21

código	acabado
1020008819	Níquel satinado / cromo brillo



Mod. BUDAPEST D-16

código	acabado
1020008817	Níquel satinado / cromo brillo



Mod. LEMANS D-70

código	acabado
1020008068	Níquel satinado / cromo brillo



Mod. LEMANS D-68

código	acabado
1020008888	Níquel satinado / cromo brillo

manillón compañero



Mod. MONTECARLO D-45

código	acabado
1020008070	Níquel satinado / cromo brillo



Mod. KIEV D-23

código	acabado
1020008818	Níquel satinado / cromo brillo



Mod. LYON D-37

código	acabado
1020008812	Níquel satinado / cromo brillo



Mod. MUNICH D-10

código	acabado
1020008815	Níquel satinado / cromo brillo

01.1 manivelas / rosetas



MÓNACO D-60

código	acabado
1020008069	Níquel satinado / cromo brillo

Mod. MÓNACO D-65

código	acabado
1020008066	Níquel satinado / cromo brillo

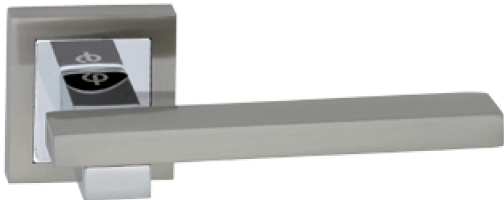
manillón compañero

Mod. MONZA D-50

código	acabado
1020008067	Níquel satinado / cromo brillo

Mod. MONZA D-62

código	acabado
1020008063	Níquel satinado / cromo brillo

manillón compañero

NIZA D-40

código	acabado
1020008814	Níquel satinado / cromo brillo

Mod. VARSOVIA D-11

código	acabado
1020008816	Níquel satinado / cromo brillo

Mod. P-9003

código	acabado
1020009456	Níquel satinado

Mod. LOG.GIC 117

código	acabado
1020003902	Níquel satinado



Mod. SPA D-80

código	acabado
1020008065	Níquel satinado



Mod. SPA D-85

código	acabado
1020008064	Níquel satinado

manillón compañero



Mod. ANGOLO 817

código	acabado
1020006152	Cromo satinado



Mod. VALENTINA 119

código	acabado
1020003857	Níquel satinado



Mod. SOFT 807

código	acabado
1020005716	Cromo satinado / cromo brillo



Mod. LOTUS 980HP

código	acabado
1020009327	Níquel satinado



Mod. SYNA 620-6001

código	acabado
1020009073	Níquel satinado



Mod. SYNA 620/6501

código	acabado
1020008809	Níquel satinado

manillón compañero

01.1 manivelas / rosetas

Mod. ELÉCTRA 621-6011

código	acabado
1020009087	Níquel satinado

Mod. ELÉCTRA 621-6511

código	acabado
1020009138	Níquel satinado

manillón compañero

Mod. 8833 PERFECT

código	acabado
1020007774	Níquel satinado

manillón compañero

Mod. 8838 PERFECT

código	acabado
1020007881	Níquel Satinado

Mod. 8822 LIBERTY

código	acabado
1020008086	Níquel satinado

Mod. VENUS 1600HP

código	acabado
1020006175	Níquel satinado / cromo brillo

Mod. ONIS D-12

código	acabado
1020006800	Níquel satinado / cromo brillo

manillón compañero

Mod. MRH-31

código	acabado
1020009144	Níquel satinado / cromo brillo

Mod. BACO D-35

código	acabado
1020007685	Níquel satinado / cromo brillo

manillón compañero

**Mod. MRH-30**

código	acabado
1020009171	Níquel satinado / cromo brillo

**Mod. MAN-H30/200**

código	acabado
1020009488	Níquel satinado / cromo brillo

manillón compañero

**Mod. 613-5001**

código	acabado
1020009008	Níquel satinado

**Mod. 713-5501**

código	acabado
1020009011	Níquel satinado

manillón compañero

**Mod. MARINA 2300HP**

código	acabado
1020008827	Níquel satinado / cromo brillo

**Mod. ALBA 2130HP**

código	acabado
1020008071	Níquel satinado

**Mod. ALICIA 2200HP**

código	acabado
1020008112	Níquel satinado / cromo brillo

**Mod. MÓDENA 1800**

código	acabado
1020006922	Níquel satinado

01.1 manivelas / rosetas



Mod. R10155SN	
código	acabado
1020006963	Níquel satinado



Mod. 610-5501	
código	acabado
1020009085	Níquel satinado

manillón compañero



Mod. 611-5001	
código	acabado
1020009072	Níquel satinado



Mod. 616-5501	
código	acabado
1020009137	Níquel satinado

manillón compañero



mod. MCLR-1	
código	acabado
1020009361	Acero inoxidable



Mod. 952HP	
código	acabado
1020007258	Acero inoxidable

manillón compañero



Mod. 1820L	
código	acabado
1020008038	Acero inoxidable



Mod. 810-4101/200	
código	acabado
1020009350	Acero inoxidable

manillón compañero



Mod. 1821U	
código	acabado
1020008065	Acero Inoxidable



Mod. 810-4201/250	
código	acabado
1020009351	Acero Inoxidable

manillón compañero



Mod. SOFT 807	
código	acabado
1020005717	Latón satinado / latón pulido



Mod. EVA 1920HP	
código	acabado
1020008704	Latón mate

manillón compañero

Mod. 616-5502	
código	acabado
1020009142	Latón mate

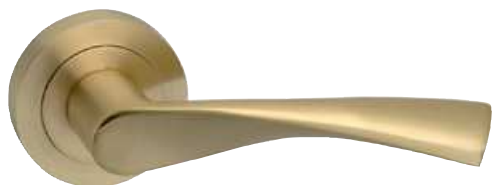

Mod. MARDO-1	
código	acabado
1020009363	Latón mate



Mod. 610-5502	
código	acabado
1020009353	Latón mate

manillón compañero



Mod. KIEV D-24	
código	acabado
1020008821	Níquel satinado / bronce



Mod. LISBOA D-22	
código	acabado
1020008822	Níquel satinado / bronce

01.1 manivelas / rosetas



Mod. P-103	
código	acabado
1020009379	Latón patinado



Mod. P-133	
código	acabado
1020009246	Latón patinado



mod. 119-VALENTINA	
código	acabado
1020006493	Fumé



Mod. ANA 2110HP	
código	acabado
1020006923	Bronce



Mod. 5054-04	
código	acabado
1020008396	Cuero satinado

manillón compañero

Mod. 5253-03	
código	acabado
1020008141	Níquel satinado / cromo brillo



Mod. EVA 1910HP	
código	acabado
1020008641	Bronce

manillón compañero

Mod. 616-5506	
código	acabado
1020009248	Bronce



Mod. MARDV-1	
código	acabado
1020009362	Bronce

manillón compañero



Mod. 610-5506	
código	acabado
1020008981	Bronce

**Mod. P-143**

código	acabado
1020009396	Latón patinado / craquelé

manillón compañero

**Mod. P-141LP**

código	acabado
1020009392	Latón patinado / craquelé

**Mod. P-143**

código	acabado
1020009397	Plata envejecida / craquelé

manillón compañero

**Mod. P-143 PE**

código	acabado
1020009393	Plata envejecida / craquelé

**Mod. AXARQUIA 350**

código	acabado
1020007815	Bronce envejecida / craquelé

manillón compañero

Mod. AXARQUIA 710

código	acabado
1020007816	Bronce envejecida / craquelé

**Mod. 8817 MONDE**

código	acabado
1020007875	Bronce envejecida / craquelé

manillón compañero

Mod. 8819 MAGNA

código	acabado
1020007225	Níquel satinado

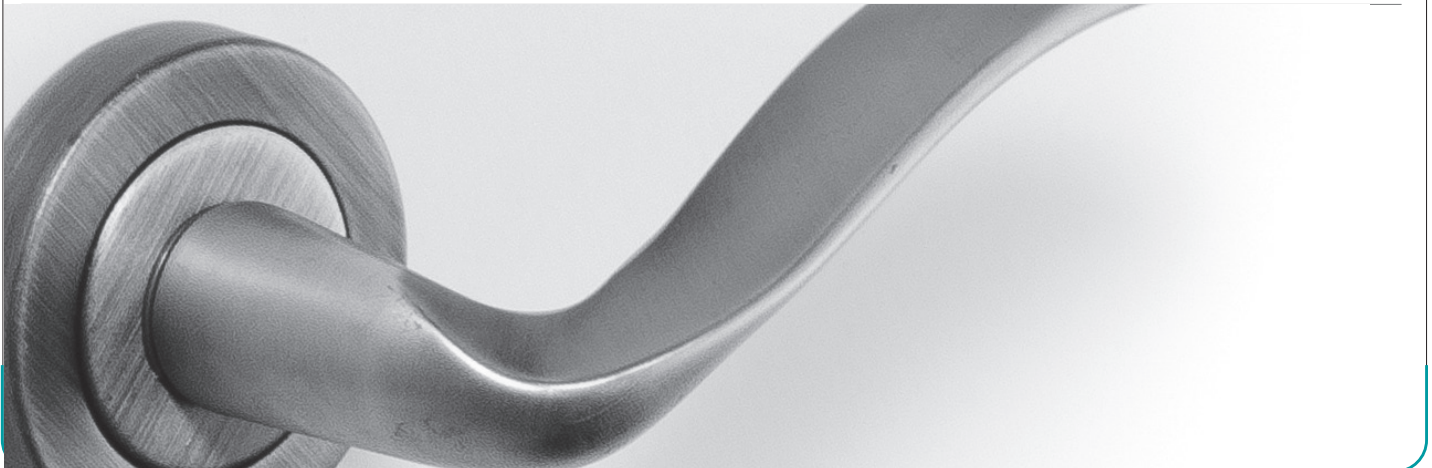

01.2 manivelas / placas



Mod. LISBOA D-29	
código	acabado
1020008844	Níquel satinado



Mod. KIEV D-30	
código	acabado
1020008845	Níquel satinado



Mod. MÓNACO D-61	
código	acabado
1020008847	Níquel satinado / cromo brillo



Mod. MÓNACO D-65	
código	acabado
1020008066	Níquel satinado / cromo brillo

manillón compañero



Mod. MONZA D-51	
código	acabado
1020008824	Níquel satinado / cromo brillo



Mod. MONZA D-62	
código	acabado
1020008063	Níquel satinado / cromo brillo

manillón compañero



Mod. D-131	
código	acabado
1020009525	Níquel satinado



Mod. MONTECARLO D-46	
código	acabado
1020008823	Níquel satinado / cromo brillo



Mod. BUDAPEST D-27	
código	acabado
1020008843	Níquel satinado / cromo brillo



Mod. CAPRI D-19	
código	acabado
1020008952	Níquel satinado



Mod. LYON D-73	
código	acabado
1020008951	Níquel satinado



Mod. MUNICH D-25	
código	acabado
1020008841	Níquel satinado

01.2 manivelas / placas



Mod. VARSOVIA D-26

código	acabado
1020008842	Níquel satinado / cromo brillo



Mod. VENUS 1601HP

código	acabado
1020008075	Níquel satinado / cromo brillo



Mod. LIDIA 2401HP

código	acabado
1020008076	Níquel satinado / cromo brillo



Mod. 610-0101

código	acabado
1020008977	Níquel satinado



Mod. 611-0101

código	acabado
1020008539	Níquel satinado



Mod. 1824-L

código	acabado
1020009354	Acero inoxidable



Mod. MARCO 956HP	
código	acabado
1020009059	Acero inoxidable



Mod. 952HP	
código	acabado
1020007258	Acero inoxidable

manillón compañero



Mod.1825-U	
código	acabado
1020009270	Acero inoxidable



Mod. 2000-U	
código	acabado
1020008611	Acero inoxidable



Mod. 203	
código	acabado
1020009683	Brillo satinado



Mod. MARIOLA 160HP	
código	acabado
1020007638	Brillo satinado

manillón compañero

01.2 manivelas / placas



Mod. P-152 LBS	
código	acabado
1020009400	Latón brillo satinado



Mod. P-151 LBS	
código	acabado
1020009398	Latón brillo satinado

manillón compañero



Mod. P-162 LBS	
código	acabado
1020009406	Latón brillo satinado



Mod. P-161	
código	acabado
1020009404	Latón brillo satinado

manillón compañero



Mod. MPO-1	
código	acabado
1020009223	Pulido brillo



Mod. OMEGA MPO-2	
código	acabado
1020009146	Pulido brillo



Mod. 5005-00

código	acabado
1020008551	Brillo satinado

manillón compañero

Mod. 5005-02

1020008552	Brillo satinado
------------	-----------------



Mod. 7486-00

código	acabado
1020009258	Brillo satinado

manillón compañero

Mod. 7005-02

1020008603	Brillo satinado
------------	-----------------



Mod. 5010

código	acabado
1020008927	Brillo satinado

manillón compañero

Mod. 5002

1020009375	Brillo satinado
------------	-----------------



Mod. ANDREA

código	acabado
1020000779	Brillo satinado

manillón compañero

Mod. ANDREA

1020009393	Brillo satinado
------------	-----------------



Mod. 2600

código	acabado
1020000715	Brillo satinado

manillón compañero

Mod. 2602

1020000728	Brillo satinado
------------	-----------------



Mod. 2750

código	acabado
1020003978	Brillo satinado

manillón compañero

Mod. 2752

1020004460	Brillo satinado
------------	-----------------

01.2 manivelas / placas



Mod. 7151-00	
código	acabado
1020008694	Pátina negra



Mod. 7151-02 PATINA NEGRA	
código	acabado
1020008853	Pátina negra

manillón compañero



Mod. P-152 LP	
código	acabado
1020009401	Latón patinado



Mod. P-151 LP	
código	acabado
1020009399	Latón patinado

manillón compañero



Mod. P-162 LP	
código	acabado
1020009407	Latón patinado



Mod. P-161 LP	
código	acabado
1020009405	Latón patinado

manillón compañero



Mod. P-132	
código	acabado
1020009114	Latón patinado



Mod. P-121 -LP	
código	acabado
1020009383	Latón patinado

manillón compañero



Mod. 2605-00	
código	acabado
1020008378	Cuero



Mod. 2605-02	
código	acabado
1020008400	Cuero

manillón compañero



Mod. 5010	
código	acabado
1020006519	Cuero



Mod. ANDREA	
código	acabado
1020004521	Bronce inglés

manillón compañero

Mod. 5002	
código	acabado
1020006561	Cuero

manillón compañero

Mod. ANDREA	
código	acabado
1020004522	Bronce inglés

01.2 manivelas / placas



manillón compañero

Mod. 2700	
código	acabado
1020000718	Bronce ingles
Mod. 2702	
1020000731	Bronce inglés



manillón compañero

Mod. 2600	
código	acabado
1020004314	Bronce ingles
Mod.2602	
1020004589	Bronce inglés



manillón compañero

Mod. 2750	
código	acabado
1020003977	Bronce inglés
Mod. 2752	
1020004460	Bronce inglés



manillón compañero

Mod. 2238-A	
código	acabado
1020003823	Bronce inglés
Mod. 2238-B	
1020005187	Bronce inglés



Mod. 7005	
código	acabado
1020008553	Brillo satinado
1020008984	Níquel satinado



Mod. AXARQUIA-351	
código	acabado
1020008185	Bronce envejecido / craquelé



Mod. P-142

código	acabado
1020009170	Latón patinado

manillón compañero



Mod. P-141

código	acabado
1020009392	Latón patinado / craquelé



Mod. P-142

código	acabado
1020009475	Plata envejecida / craquelé

manillón compañero



Mod. P-141

código	acabado
1020009393	Plata envejecida / craquelé



01.3 manivelas / accesorios

CONDENA-DESCONDENA CON ROSETA 35 mm.

código	referencia	acabado
1020008959	112-HP	Acero inoxidable
1020008962	700-3501	Níquel satinado
1020009267	700-3502	Latón satinado
1020009055	700-3506	Cuero
1020009245	P-305-LP	Latón patinado
1020009366	P-305-BE	Bronce envejecido
1020009489	P-305-PE	Plata envejecida



MUR-2



MUR-3



834

CONDENA-DESCONDENA CON ROSETA

código	referencia	acabado
1010009095	MUR-2 / INDICADOR	Acero inoxidable
1010009002	MUR-3	Acero inoxidable
1020008585	834 MINUSVÁLIDOS	Acero inoxidable

CONDENA-DESCONDENA

código	referencia	acabado
1020009443	P-601-NM	Níquel mate
1020004159	530-LP	Latón pulido
1020008726	530-BI	Bronce inglés
1020009442	P-601-BE	Bronce envejecido
1020009444	P-601-PV	Plata vieja

CONDENA 1

código	referencia	acabado
1020004994	CONDENA 1	Latón cromo mate
1020006013	CONDENA 1	Latón cuero
1020000203	CONDENA 1	Latón pulido

BOCALLAVE ROSETA

código	referencia	acabado
1020009066	710-5101 50x50 mm.	Níquel Satinado
1020009091	710-5102 50x50 mm.	Níquel Satinado
1020009090	710-5106 50x50 mm.	Cuero
1020007047	BOC-1 53x53 mm.	Acero inoxidable

BOCALLAVE ROSETA CUADRADA

código	referencia	acabado
1020009068	710-6101 CUADRADA 50x50 mm.	Níquel satinado
1020009215	BOC-C1 53x53 mm.	Acero Inoxidable



TIRADOR ARMARIO P-201

código	referencia	acabado
1020009410	P-201 S/B	Latón brillo satinado
1020009411	P-201 S/B	Latón patinado



TIRADOR MALETERO P-200

código	referencia	acabado
1020009408	TIRADOR P-200	Latón brillo satinado
1020009409	TIRADOR P-200	Latón patinado



TIRADOR ARMARIO 710

código	referencia	acabado
1020009021	S/B 710-0601	Niquel satinado
1020008697	S/B 710-0606	Cuero



TIRADOR MALETERO 710

código	referencia	acabado
1020009022	710-0801	Niquel satinado
1020008698	710-0806	Cuero



TIRADOR ARMARIO S/B 402-A

código	acabado
1020007681	Niquel satinado



TIRADOR MALETERO 402-M

código	acabado
1020007682	Niquel satinado



TIRADOR ARMARIO INOX

código	descripción	acabado
1020006330	TIRADOR ARMARIO S/B 175	Acero inoxidable
1020006338	TIRADOR ARMARIO C/B 178	Acero inoxidable
1020006339	TIRADOR MALETERO 176	Acero inoxidable

02 bisagras y pernios

PERNIO DE LATÓN 405 AMIG

código	descripción
1020000337	405 DE 80 DERECHA LATÓN MATE
1020000304	405 DE 80 IZQUIERDA LATÓN MATE
1020000338	405 DE 95 DERECHA LATÓN MATE
1020000305	405 DE 95 IZQUIERDA LATÓN MATE

PERNIO DE LATÓN 407 AMIG

código	descripción
1020000339	407 DE 80 DERECHA LATÓN MATE
1020000306	407 DE 80 IZQUIERDA LATÓN MATE
1020005475	407 DE 80 DERECHA LATÓN CUERO
1020005476	407 DE 80 IZQUIERDA LATÓN CUERO
1020000340	407 DE 95 DERECHA LATÓN MATE
1020000307	407 DE 95 IZQUIERDA LATÓN MATE
1020005406	407 DE 95 DERECHA LATÓN CUERO
1020005405	407 DE 95 IZQUIERDA LATÓN CUERO
1020006443	407 DE 100 DERECHA LATÓN MATE
1020006444	407 DE 100 IZQUIERDA LATÓN MATE
1020007245	407 DE 100 DERECHA LATÓN CUERO
1020007246	407 DE 100 IZQUIERDA LATÓN CUERO

PERNIO DE LATÓN 405 AMIG

código	descripción
1020000322	405 DE 80 DERECHA LATONADO
1020000289	405 DE 80 IZQUIERDA LATONADO
1020004022	405 DE 80 DERECHA NEGRO
1020004023	405 DE 80 IZQUIERDA NEGRO
1020000324	405 DE 95 DERECHA LATONADO
1020000291	405 DE 95 IZQUIERDA LATONADO
1020000346	405 DE 95 DERECHA NEGRO
1020000311	405 DE 95 IZQUIERDA NEGRO
1020006984	405 DE 95 DERECHA CUERO
1020006985	405 DE 95 IZQUIERDA CUERO



PERNIO DE LATÓN 408 AMIG

código	descripción
1020004615	408 DE 80 DERECHA LATONADO
1020004616	408 DE 80 IZQUIERDA LATONADO
1020004025	408 DE 80 DERECHA NEGRO
1020004024	408 DE 80 IZQUIERDA NEGRO
1020000330	408 DE 95 DERECHA LATONADO
1020000297	408 DE 95 IZQUIERDA LATONADO
1020000344	408 DE 95 DERECHA NEGRO
1020000313	408 DE 95 IZQUIERDA NEGRO
1020007283	408 DE 100 DERECHA NEGRO
1020007284	408 DE 100 IZQUIERDA NEGRO

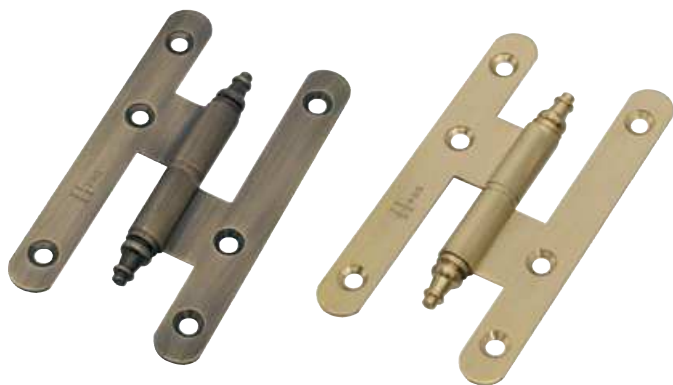

PERNIO DE HIERRO 403 C

código	descripción
1020009194	403-C 95 DERECHA NIQUEL SATINADO
1020009195	403-C 95 IZQUIERDA NIQUEL SATINADO
1020009153	403-C 100 DERECHA NIQUEL SATINADO
1020009154	403-C 100 IZQUIERDA NIQUEL SATINADO



PERNIO DE HIERRO 406

código	descripción
1020009165	406 DE 100 DERECHA LATONADO MATE
1020009164	406 DE 100 IZQUIERDA LATONADO MATE
1020009166	406 DE 100 DERECHA CUERO
1020009168	406 DE 100 IZQUIERDA CUERO



PERNIO DE ACERO INOXIDABLE

código	descripción
1020006358	492 DE 80 DERECHA INOXIDABLE
1020006357	492 DE 80 IZQUIERDA INOXIDABLE
1020004843	490 DE 95 DERECHA INOXIDABLE
1020004844	490 DE 95 IZQUIERDA INOXIDABLE
1020006158	405 DE 100 DERECHA INOXIDABLE
1020006159	406 DE 100 IZQUIERDA INOXIDABLE



PERNIO 395

código	descripción
1020000331	395 DE 3" DERECHA BICROMATIZADO
1020000298	395 DE 3" IZQUIERDA BICROMATIZADO
1020000316	395 DE 3" DERECHA LATONADO
1020000283	395 DE 3" IZQUIERDA LATONADO
1020005212	395 DE 4" DERECHA BICROMATIZADO
1020005213	395 DE 4" IZQUIERDA BICROMATIZADO
1020000317	395 DE 4" DERECHA LATONADO
1020000284	395 DE 4" IZQUIERDA LATONADO
1020000333	395 DE 5" DERECHA BICROMATIZADO
1020000300	395 DE 5" IZQUIERDA BICROMATIZADO
1020000318	395 DE 5" DERECHA LATONADO
1020000285	395 DE 5" IZQUIERDA LATONADO
1020000334	395 DE 6" DERECHA BICROMATIZADO
1020000301	395 DE 6" IZQUIERDA BICROMATIZADO

02 bisagras y pernios

**BISAGRA ANTIPALANCA
CANTO REDONDO**

código	descripción
	Medidas: 150x80 mm.
1020008656	483-R NÍQUEL SATINADO
1020008673	483-R BRONCE
1020008674	483-R LATONADO
1020008693	483-R NEGRO

**BISAGRA ANTIPALANCA
CANTO CUADRADO**

código	descripción
	Medidas: 150x80 mm.
1020008722	483 NÍQUEL SATINADO
1020008672	483 BRONCE
1020008671	483 LATONADO
1020008758	483 NEGRO

BISAGRA ANTIPALANCA DE LATÓN

código	descripción
	Medidas: 150x80 mm.
1020006484	456 LATÓN SATINADO

BISAGRA ANTIPALANCA SIN REMATE

código	descripción
	Medidas: 150x80 mm.
1020005914	ACERO INOXIDABLE
1020009551	NÍQUEL SATINADO
1020009221	CANTO REDONDO NÍQUEL SAT.

BISAGRA 496

código	descripción
	Medidas: 140x80 mm.
1020005229	496 DERECHA ACERO INOX.
1020005490	497 IZQUIERDA ACERO INOX.

BISAGRA 8900

código	descripción
	Medidas: 120x80 mm.
1020008714	8900 120x80 DCHA LATÓN SAT.
1020008715	8901 120x80 IZQ. LATÓN SAT.



BISAGRA 1007	
código	descripción
	Medidas: 100x70 mm.
1020000156	1007 DERECHA LATÓN
1020000148	1007 IZQUIERDA LATÓN
1020006449	1007 DRCHA. LATÓN CUERO
1020006549	1007 IZQUIERDA LATÓN CUERO



BISAGRA 423	
código	descripción
	Medidas: 90x65 mm.
1020006613	423 DERECHA ACERO INOX.
1020006614	423 IZQUIERDA ACERO INOX.



BISAGRA 424	
código	descripción
	Medidas: 90x65 mm.
1020009277	424 DERECHA ACERO INOX.
1020009278	424 IZQUIERDA ACERO INOX.



BISAGRA DE VAIVÉN DOBLE ACCIÓN	
código	descripción
1020007233	HP5050 BLANCO
1020007172	HP5150 ORO
1020007157	HP5250 PLATA
1020007156	HP5350 BRONCE
1020007171	HP5450 NEGRO
1020005594	4330 INOX.



BISAGRA DE VAIVÉN SIMPLE ACCIÓN	
código	descripción
1020007175	BISAGRA HP5100 ORO
1020007173	BISAGRA SIMPLE PLATA
1020007234	BISAGRA HP5300 BRONCE H-PR
1020007174	BISAGRA HP5400 NEGRO



BISAGRA OCULTA KRONA	
código	descripción
1020008776	K-6100-20
1020009287	K-6200-CS

02 bisagras y pernios

BISAGRA OCULTA

código	descripción
	Ángulo de apertura hasta 180°. Para puertas desde 20 mm. de espesor
1020008392	HP5950 44x127 mm. 10 Kgr. NIQUEL SATINADO
1020009260	BC-70/16 70x16 mm. 20 Kgr. NIQUEL SATINADO
1020007956	HP6100 95'2x17 mm. 30 Kgr. NIQUEL SATINADO

BISAGRA OCULTA CON REGULACIÓN

código	descripción
	Ángulo de apertura hasta 180°. Para puertas desde 35 mm. de espesor
1020007960	HP6400 95x43 mm. 40 Kgr. Derecha NIQUEL SATINADO
1020007961	HP6401 95x43 mm. 40 Kgr. Izquierda NIQUEL SATINADO

BISAGRA PIVOTANTE

código	descripción
1020009196	10100 ACERO INOXIDABLE

03 pomos, manillones y llamadores

POMO P-402

código	acabado
1020009289	NIQUEL SATINADO

POMO P-402

código	acabado
1020009290	PULIDO BRILLO

POMO P-402

código	acabado
1020009291	LATÓN PATINADO

POMO 141HP

código	acabado
1020008036	PULIDO BRILLO

POMO 142HP

código	acabado
1020007753	NIQUEL SATINADO

POMO 143HP

código	acabado
1020008682	BRONCE

pomos, manillones y llamadores 03



POMO P-401

código	acabado
1020009427	BRONCE ENVEJECIDO



POMO P-401

código	acabado
1020009373	PLATA ENVEJECIDA



POMO LATÓN ESTRELLA

Código	descripción
1020002231	Pomo 400lb (65x55 mm.) LATÓN BRILLO
1020002231	Pomo 400lp (65x55 mm.) LATÓN PATINADO
1020002238	Pomo 404lb (65x80 mm.) LATÓN BRILLO
1020002236	Pomo 404lp (65x80 mm.) LATÓN PATINADO



POMO 880

código	acabado
1020005182	ACERO INOXIDABLE



POMO 3350

código	acabado
1020009169	ACERO INOXIDABLE



POMO 903

código	acabado
1020007798	NÍQUEL SATINADO



MANILLÓN 184

código	acabado
1020002090	MANILLÓN 184LB LATÓN BRILLO
1020002091	MANILLÓN 184LP LATÓN PATINADO



MANILLÓN 240

Código	acabado
1020002104	MANILLÓN 240Lb LATÓN BRILLO
1020002105	MANILLÓN 240Lp LATÓN PATINADO
1020002107	MANILLÓN 240Nm LATÓN NÍQUEL MATE

03 pomos, manillones y llamadores

MANILLÓN SHANGHAI 6105 (320 mm.)

código	acabado
1020007256	ACERO INOXIDABLE

LLAMADOR ARO

código	descripción
10200002045	948 LB (135x110 mm.) LATÓN BRILLO
10200002046	948 LP (135x110 mm.) LATÓN PATINADO
10200002048	948 NM (135x110 mm.) LATÓN NÍQUEL MATE
1020002049	952 LB (160x130 mm.) LATÓN BRILLO
1020003400	952 LP (160x130 mm.) LATÓN PATINADO

LLAMADOR 912

código	descripción
1020002057	912 LB (215 mm.) LATÓN BRILLO
1020003398	912 LP (215 mm.) LATÓN PATINADO

CLAVO 1300 (35 mm.)

código	descripción
1020001978	CLAVO 1300LB LATÓN BRILLO
1020001979	CLAVO 1300LP LATÓN PATINADO

CLAVO 1302 (42 mm.)

código	descripción
1020001980	CLAVO 1302LB LATÓN BRILLO
1020001981	CLAVO 1302LP LATÓN PATINADO



PASADOR EMBUTIDO 401	
código	descripción
1020005117	401 DE 150 CROMO MATE
1020004930	401 DE 150 CUERO
1020005121	401 DE 150 INOX
1020003993	401 DE 150 LATONADO
1020006527	401 DE 150 NEGRO
1020005118	401 DE 200 CROMO MATE
1020004931	401 DE 200 CUERO
1020005122	401 DE 200 INOX
1020003994	401 DE 200 LATONADO
1020006528	401 DE 200 NEGRO

1020005119	401 DE 250 CROMO MATE
1020004932	401 DE 250 CUERO
1020005123	401 DE 250 INOX
1020004987	401 DE 250 LATONADO
1020006529	401 DE 250 NEGRO
1020005120	401 DE 300 CROMO MATE
1020004933	401 DE 300 CUERO
1020005124	401 DE 300 INOX
1020000263	401 DE 300 LATONADO
1020006530	401 DE 300 NEGRO
1020000264	401 DE 400 LATONADO
1020005407	401 DE 500 LATONADO



PASADOR 2302	
código	descripción
1020001301	2302 DE 15 LATONADO
1020007568	2302 DE 15 NÍQUEL MATE
1020001302	2302 DE 20 LATONADO
1020007569	2302 DE 20 NÍQUEL MATE
1020001303	2302 DE 25 LATONADO
1020007570	2302 DE 25 NÍQUEL MATE
1020001304	2302 DE 30 LATONADO
1020007571	2302 DE 30 NÍQUEL MATE
1020001305	2302 DE 40 LATONADO
1020007572	2302 DE 40 NÍQUEL MATE
1020001306	2302 DE 50 LATONADO
1020007573	2302 DE 50 NÍQUEL MATE



PASADOR 302	
código	descripción
1020001284	302 DE 20 BICROMATIZADO
1020001285	302 DE 25 BICROMATIZADO
1020001286	302 DE 30 BICROMATIZADO
1020001287	302 DE 40 BICROMATIZADO
1020001288	302 DE 50 BICROMATIZADO
1020001289	302 DE 60 BICROMATIZADO
1020001290	302 DE 70 BICROMATIZADO
1020001291	302 DE 80 BICROMATIZADO
1020001292	302 DE 90 BICROMATIZADO
1020001293	302 DE 100 BICROMATIZADO

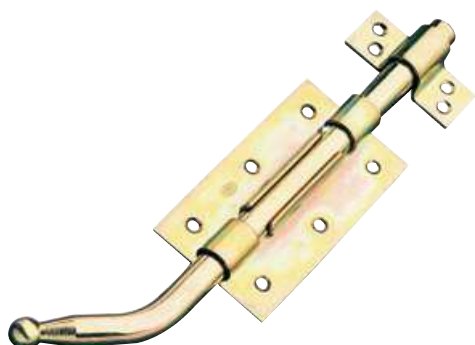

PASADOR 320	
código	descripción
1020000213	320 de 300 BICROMATIZADO
1020000214	320 de 400 BICROMATIZADO
1020000215	320 de 500 BICROMATIZADO

04 pasadores

PASADOR 3700 LATÓN

código	descripción
1020006570	3700 DE 250 LATÓN CUERO
1020006635	3700 DE 250 LATÓN MATE
1020008175	3700 DE 300 CROMO MATE
1020006571	3700 DE 300 LATÓN CUERO
1020006636	3700 DE 300 LATÓN MATE
1020006572	3700 DE 400 LATÓN CUERO
1020006637	3700 DE 400 LATÓN MATE
1020007808	3700 DE 500 CROMO MATE
1020006573	3700 DE 500 LATÓN CUERO
1020006638	3700 DE 500 LATÓN MATE

PASADOR LA ESTERLLA LATÓN

código	descripción
1020002148	PASDOR 1416 DE 200 LATÓN PATINADO
1020002150	PASDOR 1416 DE 200 NÍQUEL SATINADO
1020002162	PASDOR 1418 DE 300 LATÓN PATINADO
1020002164	PASDOR 1418 DE 300 NÍQUEL SATINADO
1020003408	PASDOR 1422 DE 500 LATÓN PATINADO
1020004537	PASDOR 1422 DE 500 NÍQUEL SATINADO

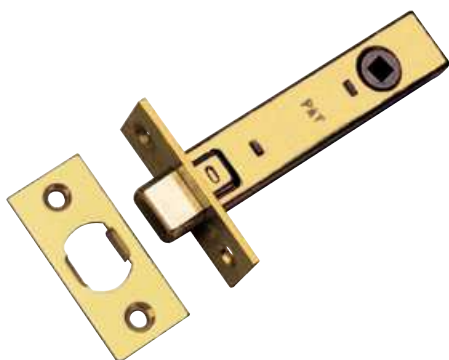
PASADOR MULETILLA DE EMBUTIR 126

código	descripción
1020000275	126 DE 35 LATONADO
1020000276	126 DE 45 LATONADO
1020007706	126 DE 45 CANTO REDONDO LATONADO
1020000279	126 DE 45 NÍQUEL
1020006524	126 DE 45 CUERO
1020006526	126 DE 45 NEGRO
1020000277	126 DE 60 LATONADO
1020000280	126 DE 60 NÍQUEL
1020006525	126 DE 60 CUERO
1020006522	126 DE 60 NEGRO
1020000278	126 DE 70 LATONADO

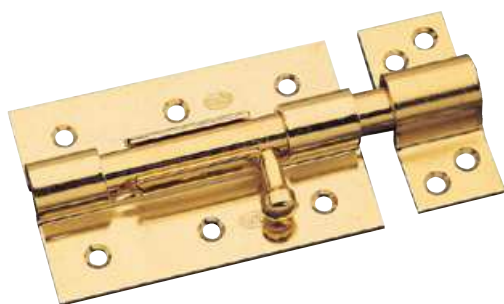
PASADOR 454

código	descripción
1020000265	454 DE 70 LATONADO
1020000266	454 DE 85 LATONADO
1020000267	454 DE 100 LATONADO
1020000268	454 DE 120 LATONADO

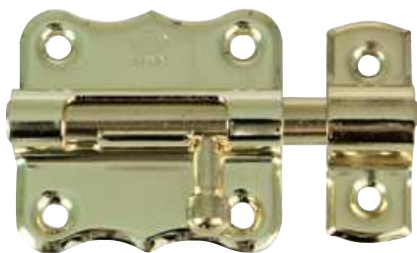
**PASADOR 384**

código	descripción
1020000245	384 DE 30 LATONADO
1020000246	384 DE 35 LATONADO
1020000247	384 DE 40 LATONADO
1020000248	384 DE 50 LATONADO
1020000249	384 DE 60 LATONADO

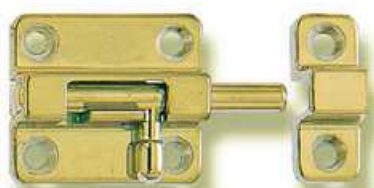
**PASADOR 973**

código	descripción
1020000406	973 DE 50 CROMO MATE
1020000407	973 DE 50 LATONADO
1020000411	973 DE 70 LATONADO

**PASADOR 390**

código	descripción
1020000251	390 DE 30 LATONADO
1020000252	390 DE 40 LATONADO
1020000253	390 DE 50 LATONADO

**PASADOR 615**

código	descripción
1020007237	615 DE 35 mm. BRONCE
1020007278	615 DE 35 mm. LATÓN SATINADO
1020007217	615 DE 35 mm. NÍQUEL SATINADO
1020006946	615 DE 40 mm. BRONCE
1020006943	615 DE 40 mm. LATÓN PULIDO
1020006944	615 DE 40 mm. NÍQUEL CEPILLADO
1020009160	615 DE 50 mm. BRONCE
1020009161	615 DE 50 mm. LATÓN PULIDO
1020005184	616 DE 40 mm. ACERO INOX

**PASADOR 620**

código	descripción
1020008666	620 DE 30 mm. BRONCE
1020008664	620 DE 30 mm. LATONADO
1020008665	620 DE 30 mm. NÍQUEL CEPILLADO

**PASADOR 970**

código	descripción
1020003599	PASADOR 970 CROMO BRILLO
1020000448	PASADOR 970 LATONADO

05 mirillas



MIRILLA DIGITAL 753

código	descripción
1020008510	753 VISOR NÍQUEL MATE/MIRILLA DORADA
1020009498	753 VISOR NÍQUEL MATE/MIRILLA CROMO BRILLO



La mirilla tiene un timbre incorporado que activa automáticamente la pantalla y registra fotos de las llamadas hechas junto con la hora. Podrá saber fácilmente quién le ha visitado en su ausencia.

Podrá grabar fotos y video cuando quiera con tan sólo pulsar un botón. Cámara con infrarrojos que le permite ver en total oscuridad. Tarjeta micro-sd de 512mb.

MIRILLA DIGITAL 751 NÍQUEL SATINADO

código	acabado
1020009499	NÍQUEL SATINADO



MIRILLA DIGITAL C-52

código	descripción
1020009281	C-52 DORADA
1020009313	C-52 PLATA



MIRILLA ÓPTICA DE 10 A 15 mm.

código	descripción
1020000202	MIRILLA 6-12 LATÓN SATINADO



MIRILLA DE LATÓN 1105

código	descripción
1020002021	1105-LB LATÓN BRILLO
1020007212	1105-LA LATÓN PATINADO

**MIRILLA ÓPTICA DE 15 A 25 mm.**

código	descripción
102000200	MIRILLA 4-14 LATÓN SATINADO
1020009477	MIRILLA 4-14 CUERO
1020006329	MIRILLA 52HP 15-25 CROMO MATE
1020006337	MIRILLA 55HP 15-25 NEGRO

**MIRILLA ÓPTICA DE 25 A 42 mm.**

código	descripción
1020000198	MIRILLA 2-14 LATÓN SATINADO
1020009265	MIRILLA 2-14 CUERO
1020006323	MIRILLA 2-14 CROMO MATE
1020006336	MIRILLA 55HP NEGRO

**MIRILLA ÓPTICA DE 35 A 60 mm.**

código	descripción
1020000199	MIRILLA 3-14 LATÓN SATINADO
1020003194	MIRILLA 3-14 CUERO
1020003195	MIRILLA 3-14 CROMO MATE
1020006335	MIRILLA 55HP NEGRO

**MIRILLA ÓPTICA DE 60 A 85 mm.**

código	descripción
1020000201	MIRILLA 5-16 LATÓN SATINADO
1020009330	MIRILLA 5-16 CUERO
1020006900	MIRILLA 5-16 CROMO MATE

**EMBELLECEDOR MIRILLA 1101**

código	descripción
1020001990	1101-LB LATÓN BRILLO
1020006401	1101-NM LATÓN NIQUEL MATE
1020006349	1101-LP LATÓN PATINADO

**EMBELLECEDOR MIRILLA 1102**

código	descripción
1020001994	1102-LB LATÓN BRILLO
1020001997	1102-NM LATÓN NIQUEL MATE
1020001995	1102-LP LATÓN PATINADO

06 retenedores y topes para puerta

RETENEDOR CON CADENA DE SEGURIDAD N°1

código	acabado
1020000168	LATONADO
1020005894	CUERO
1020005893	CROMO MATE

RETENEDOR DE SEGURIDAD N°2

código	acabado
1020004068	LATONADO
1020007645	CUERO
1020007686	CROMO MATE

RETENEDOR DE PUERTA 143

código	descripción
1020001363	143.00.1 LATONADO

TOPE RETENEDOR DE PUERTA MAGNÉTICO 700

código	acabado
1020005793	CUERO
1020005794	NÍQUEL CEPILLADO

TOPE RETENEDOR DE PUERTA MAGNÉTICO ADHESIVO 2037

código	acabado
1020009034	2037-4 MARRÓN
1020009025	2037-7 CROMO MATE

TOPE RETENEDOR DE PUERTA ADHESIVO A-448

código	descripción
1020008949	A-448-2 BLANCO
1020008948	A-448-8 MARRÓN

TOPE PARA PUERTA H-PRO

código	descripción
1020008831	136HP 19x25 INOX
1020008830	134HP 25x30 INOX

TOPE PARA PUERTA P-800

código	descripción
1020009348	P-800 LATÓN Patinado
1020009455	P-800 NÍQUEL Mate

TOPE PARA PUERTA A-802

código	descripción
1010008078	A-802 INOX

retenedores y topes para puerta 06



TOPE ADHESIVO PARA PUERTA 2420

código	descripción
1020009027	2420-7 CROMO MATE
1020009035	2420-9- MADERA



TOPE ADHESIVO PARA PUERTA 1470

código	descripción
1020009024	1470-0A SAPELLY
1020009040	1470-3A ROBLE



TOPE ADHESIVO PARA PUERTA 2021

código	descripción
1020008580	2021-4A MARRÓN
1020008579	2021-7A CROMO MATE



TOPE ADHESIVO PARA PUERTA 2027

código	descripción
1020009036	2027-1A CROMO
1020009038	2027-3A DORADO
1020009041	2027-7A CROMO MATE



TOPE ADHESIVO PARA PUERTA 2033

código	descripción
1020009037	2033-0- TRANSLÚCIDO
1020009029	2033-2+ BLANCO
1020009030	2033-4+ MARRÓN
1020009031	2033-6+ BEIGE



TOPE ADHESIVO PARA PUERTA 2039

código	descripción
1020009039	2039-0A SAPELLY
1020009033	2039-3A ROBLE
1020009028	2039-8A HAYA



07 burletes

BURLETE EMBUTIDO DE ALUMINIO 504

código	descripción
1020008767	504 DE 400 mm. ALUMINIO
1020006018	504 DE 600 mm. ALUMINIO
1020006155	504 DE 720 mm. ALUMINIO
1020006156	504 DE 820 mm. ALUMINIO
1020006157	504 DE 1000 mm. ALUMINIO
1020008768	504 DE 1200 mm. ALUMINIO

BURLETE DE SOBREPONER DE ALUMINIO 516

código	descripción
1020008688	516 de 1000 mm. PLATA
1020008686	516 de 1000 mm. BRONCE

BURLETE ADHESIVO DE ALUMINIO 2

código	descripción
1020005578	2 DE 720 mm. PLATA
1020000163	2 DE 720 mm. ORO
1020005576	2 DE 720 mm. BRONCE
1020005574	2 DE 720 mm. BLANCO
1020005580	2 DE 720 mm. ROBLE
1020000162	2 DE 720 mm. SAPELLY
1020005579	2 DE 820 mm. PLATA
1020000165	2 DE 820 mm. ORO
1020005577	2 DE 820 mm. BRONCE
1020005575	2 DE 820 mm. BLANCO
1020000164	2 DE 820 mm. SAPELLY
1020005607	2 DE 1000 mm. PLATA
1020000167	2 DE 1000 mm. ORO
1020005612	2 DE 1000 mm. BRONCE
1020005606	2 DE 1000 mm. BLANCO
1020000166	2 DE 1000 mm. SAPELLY

BURLETE ADHESIVO 2157

código	descripción
1010008270	2157-0 900 mm. TRANSPARENTE.

BURLETE ADHESIVO DE SILICONA

código	descripción
1020008578	2110-0 600 mm TRANSPARENTE
1020008577	2110-4 600 mm MARRÓN

BURLETE ADHESIVO DE CAUCHO

código	descripción
1020007849	2115-4-K 6000 mm, MARRÓN
1020007850	2116-4-P 6000 mm, MARRÓN
1020007841	2119-4-D 6000 mm, MARRÓN



- Apertura hasta 180°
- Válvula de ajuste de velocidad desde inicio a 15° finales
- Ajuste de aceleración en los últimos 15°
- Válido para puertas de 25-40 kg.
- Cuerpo de aluminio
- Dimensiones 900 x 210 mm
- Con retenedor

CIERRAPUERTAS 3302

código	acabado
1020008164	3302 PLATA
1020008863	3302 ORO
1020008364	3302 BRONCE
1020008716	3302 BLANCO
1020009135	3302 NEGRO



FALLEBA A-620

código	acabado
1020008382	A-620-10 LATONADO
1020008379	A-620-18 CROMO MATE
1020008383	A-620-20 NEGRO
1020008380	VARILLA A-622-14 1250 mm. ZINCADA
1020008384	VARILLA A-622-16 1250 mm. BICROMATIZADA
1020008385	VARILLA A-622-20 1250 mm NEGRO



FALLEBA P-702

código	acabado
1020009452	P-702 LATÓN PATINADO
1020009453	P-702 NÍQUEL MATE
1020009454	VARILLA P-705 (1200 mm.) LATÓN PATINADO
1020009365	VARILLA P-705 (1200 mm.) NÍQUEL MATE



FALLEBA P-700

código	acabado
1020009239	P-700 LP LATÓN PATINADO
1020009240	P-700 NM LATÓN NÍQUEL MATE
1020009241	VARILLA P-700LP (1500 mm.) LATÓN PATINADO
1020009242	VARILLA P-700NM (1500 mm.) NÍQUEL MATE

10 soportes y escuadras

SOPORTE PASAMANOS 323

código	descripción
1020006554	323 LATONADO
1020006556	323 BRONCE
1020006555	323 NÍQUEL SATINADO

SOPORTE PASAMANOS 24

código	acabado
1020006991	NEGRO

Mod. SOPORTE PELÍCANO

código	acabado
1020007741	A-178-12 CROMO BRILLO
1020007740	A-178-2 BLANCO
1020007884	A-178-20 NEGRO
1020008850	Nº 102 CROMO MATE
1020008954	Nº 102 ORO VIEJO

SOPORTE PELÍCANO 440-A-2201

código	acabado
1020005879	NÍQUEL SATINADO

SOPORTE PELÍCANO 440-B-2201

código	acabado
1020005880	NÍQUEL SATINADO

SOPORTE PELÍCANO 442-2201

código	acabado
1020005881	NÍQUEL SATINADO

SOPORTE PELÍCANO 444-2201

código	acabado
1020005882	NÍQUEL SATINADO

SOPORTE PELÍCANO 446-2201

código	acabado
1020005884	NÍQUEL SATINADO

SOPORTE KALABRONE

código	descripción
1020008642	A-1801-84 de 8 a 30 mm. NÍQUEL SATINADO
1020008643	A-1803-84 de 25 a 50 mm. NÍQUEL SATINADO



SOPORTE PELÍCANO 448-2201

código	acabado
1020005885	NÍQUEL SATINADO



SOPORTE PELÍCANO 449-2201

código	acabado
1020005886	NÍQUEL SATINADO



SOPORTE PALOMILLA 12

código	descripción
1020009495	12 150x125 GRIS METALIZADO
1020009496	12 200x150 GRIS METALIZADO
1020009497	12 250x200 GRIS METALIZADO



SOPORTE PALOMILLA 2

código	descripción
1020000185	ÁNGULO 2 DE 150X125 BLANCO
1020000189	ÁNGULO 2 DE 150X125 MARRÓN
1020000186	ÁNGULO 2 DE 200X150 BLANCO
1020000190	ÁNGULO 2 DE 200X150 MARRÓN
1020000187	ÁNGULO 2 DE 250X200 BLANCO
1020000191	ÁNGULO 2 DE 250X200 MARRÓN
1020000188	ÁNGULO 2 DE 300X250 BLANCO
1020000192	ÁNGULO 2 DE 300X250 MARRÓN



SOPORTE PALOMILLA E-682 M

código	descripción
1020008854	E-682-2 150x125 BLANCO
1020008855	E-683-2 200x150 BLANCO
1020008856	E-684-2 250x200 BLANCO
1020008904	E-685-2 300x250 BLANCO
1020008857	E-686-2 350x300 BLANCO
1020008929	E-688-2 400x350 BLANCO



SOPORTE PALOMILLA 4

código	descripción
1020008917	150x125 NEGRO
1020008669	200x150 NEGRO
1020008670	250x200 NEGRO



SOPORTE CARTELA 8600

código	descripción
1010008877	SOPORTE CARTELA 8600-15 BLANCO
1010008876	SOPORTE CARTELA 8600-20 BLANCO
1010008749	SOPORTE CARTELA 8600-25 BLANCO
1010008754	SOPORTE CARTELA 8600-30 BLANCO
1010008734	SOPORTE CARTELA 8600-35 BLANCO
1010008744	SOPORTE CARTELA 8600-40 BLANCO



GUÍA CARTELA

código	descripción
1010008733	SIMPLE 6000-200 (2000 mm.) BLANCO
1010008732	DOBLE 7000-200 (2000 mm.) BLANCO

10 soportes y escuadras

ESCUADRA REFORZADA 3

código	descripción
1010008105	300x200 mm. REFORZADA BLANCO
1010008106	400x250 mm. REFORZADA BLANCO
1020008735	500x330 mm. REFORZADA BLANCO

ESCUADRA ABATIBLE 8

código	descripción
1020006836	ESCUADRA PALOMILLA 8-200X200 CROMO
1020003796	ESCUADRA PALOMILLA 8-300X300 CROMO
1020003797	ESCUADRA PALOMILLA 8-400X400 CROMO

ESCUADRA PLANA

código	acabado
1010008883	E-306 60x60 mm. ZINCADA
1010008884	E-308 80x80 mm. ZINCADA
1010008885	E-309 100x100 mm. ZINCADA

ÁNGULO 1

código	acabado
1010004998	ÁNGULO 1 DE 100 ZINCADO
1010003191	ÁNGULO 1 DE 20 ZINCADO
1010003192	ÁNGULO 1 DE 30 ZINCADO
1010003193	ÁNGULO 1 DE 40 ZINCADO
1010003194	ÁNGULO 1 DE 50 ZINCADO
1010003195	ÁNGULO 1 DE 60 ZINCADO
1010003196	ÁNGULO 1 DE 80 ZINCADO

ÁNGULO 732

código	acabado
1010005447	ÁNGULO 732 DE 30 BICROMATIZADO
1010005397	ÁNGULO 732 DE 40 BICROMATIZADO
1010005398	ÁNGULO 732 DE 50 BICROMATIZADO
1010005505	ÁNGULO 732 DE 60 BICROMATIZADO





LETRAS ACERO INOXIDABLE

código	descripción
1020005731	LETRAA 6762 4" INOX
1020007780	LETRA B 6763 4" INOX
1020008040	LETRA C 6764 4" INOX
1020005732	LETRA D 6765 4" INOX
1020005733	LETRA E 6766 4" INOX
1020005734	LETRA I 7278 4" INOX



NÚMEROS ACERO INOXIDABLE

código	descripción
1020005698	NÚMERO 0 6768 4" INOX
1020005699	NÚMERO 1 6769 4" INOX
1020005802	NÚMERO 2 6770 4" INOX
1020005728	NÚMERO 3 6771 4" INOX
1020005729	NÚMERO 4 6772 4" INOX
1020005730	NÚMERO 5 6773 4" INOX
1020005803	NÚMERO 6 6774 4" INOX
1020005804	NÚMERO 7 6775 4" INOX
1020005805	NÚMERO 8 6776 4" INOX
1020005700	NÚMERO 9 6777 4" INOX



NÚMEROS DE LATÓN

código	descripción
1020008100	NÚMERO 0 2669 4" LATÓN PULIDO
1020008101	NÚMERO 1 2670 4" LATÓN PULIDO
1020008102	NÚMERO 2 2671 4" LATÓN PULIDO
1020008103	NÚMERO 3 2672 4" LATÓN PULIDO
1020008104	NÚMERO 4 2673 4" LATÓN PULIDO
1020008105	NÚMERO 5 2674 4" LATÓN PULIDO
1020008106	NÚMERO 6 2675 4" LATÓN PULIDO
1020008107	NÚMERO 7 2676 4" LATÓN PULIDO
1020008108	NÚMERO 8 2677 4" LATÓN PULIDO
1020008109	NÚMERO 9 2678 4" LATÓN PULIDO

12 contramarcos y precercos

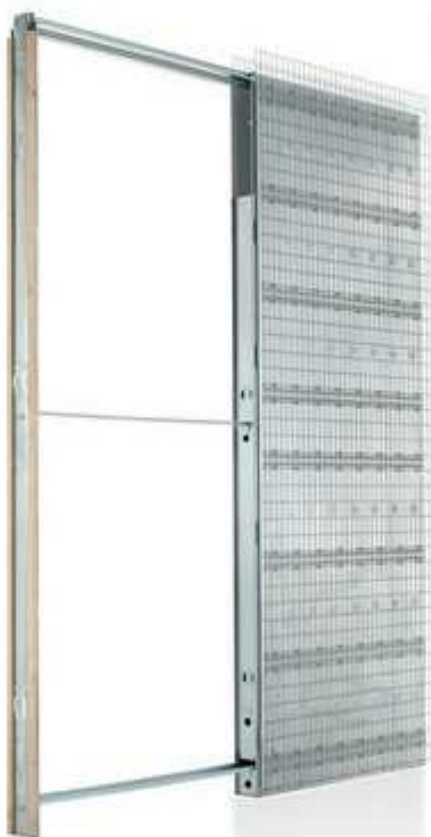
CONTRAMARCO JUNIOR

código	descripción
1020008091	CONTRAMARCO JUNIOR 600X2020 90 mm.
1020008421	CONTRAMARCO JUNIOR 700X2020 90 mm.
1020008422	CONTRAMARCO JUNIOR 800X2020 90 mm.
1020008600	CONTRAMARCO JUNIOR 900X2020 90 mm.
1020008150	CONTRAMARCO JUNIOR 600X2020 108 mm.
1020007821	CONTRAMARCO JUNIOR 700X2020 108 mm.
1020007822	CONTRAMARCO JUNIOR 800X2020 108 mm.
1020008149	CONTRAMARCO JUNIOR 900X2020 108 mm.
1020009639	CONTRAMARCO JUNIOR 1000X2020 108 mm.
1020009283	CONTRAMARCO JUNIOR 600X2100 108 mm.
1020008182	CONTRAMARCO JUNIOR 700X2100 108 mm.
1020007933	CONTRAMARCO JUNIOR 800X2100 108 mm.
1020009109	CONTRAMARCO JUNIOR 900X2100 108 mm.

CONTRAMARCO JUNIOR DOBLE

código	descripción
1020008931	CONTRAMARCO JUN. EXT. 600+600X2020 90 mm.
1020008933	CONTRAMARCO JUN. EXT. 700+700X2020 90 mm.
1020008936	CONTRAMARCO JUN. EXT. 800+800X2020 90 mm.
1020008939	CONTRAMARCO JUN. EXT. 900+900X2020 90 mm.
1020008930	CONTRAMARCO JUN. EXT. 600+600X2020 108 mm.
1020008932	CONTRAMARCO JUN. EXT. 700+700X2020 108 mm.
1020008935	CONTRAMARCO JUN. EXT. 800+800X2020 108 mm.
1020008938	CONTRAMARCO JUN. EXT. 900+900X2020 108 mm.
1020008934	CONTRAMARCO JUN. EXT. 700+700X2100 108 mm.
1020008937	CONTRAMARCO JUN. EXT. 800+800X2100 108 mm.

PRECERCO DE MADERA

código	descripción
1120000783	PASO 70x35x2030
1120000775	PASO 90x35x2030
1120000776	PASO 100x35x2030
1120000777	PASO 110x35x2030
1120000778	PASO 120x35x2030
1120000779	PASO 140x35x2030
1120000781	PASO 90x35x2110
1120000782	PASO 110x35x2110
1120000780	COMEDOR 90x35x2030



Mod. 230/104 NEGRO

código	acabado
1020006400	NEGRO



Mod. 230/104 ANTICUARIO

código	acabado
1020003529	ANTICUARIO



Mod. 1100-CASTILLA

código	acabado
1020000435	NEGRO



Mod. 1157-ANDALUCÍA

código	acabado
1020000436	NEGRO



Mod. 8811-E CANDELA

código	acabado
1020006407	NEGRO



Mod. 1457 MEDINA NEGRO

código	acabado
1020007640	NEGRO

13 estilo castellano



Mod. 1457 MEDINA ORO VIEJO

código	acabado
1020007504	ORO VIEJO



Mod. MANILLÓN 112- M

código	acabado
1020003780	NEGRO
1020003527	ANTICUARIO



Mod. 1101 NEGRO

código	acabado
1020000423	NEGRO



Mod. 1158 NEGRO

código	acabado
1020000424	NEGRO



Mod. MANILLÓN 8810-E

código	acabado
1020006500	NEGRO



Mod. CONDENA 41

código	acabado
1020007079	41 ANTICUARIO
1020004842	41 NEGRO
10200047096	42 CON DISCONDENA NEGRO



Mod. CONDENA FELIPE II

código	descripción
1020003721	40 ANTICUARIO
1020001258	40 NEGRO



Mod. CONDENA CON ESCUDO FELIPE II

código	descripción
1020004629	40/29 100x32 mm. NEGRO



Mod. BOCALLAVE 92-B

código	descripción
1020001247	175x45 mm. PERA NEGRO
1020006180	175x45 mm. PERA ANTICUARIO



Mod. BOCALLAVE 97-B

código	descripción
1010005264	70x45 mm. PERA ANTICUARIO
1020006307	70x45 mm. PERA NEGRO
1020006928	70x45 mm. REDONDA ANTICUARIO
1020005982	70x45 mm. REDONDA NEGRA



Mod. BOCALLAVE 98-B

código	descripción
1020003781	70x45 mm. NEGRO
1020007787	70x45 mm. PLATA VIEJA



Mod. POMO PUERTA 119

código	acabado
1020004567	NEGRO



Mod. POMO PUERTA 122

código	acabado
1020001332	NEGRO



Mod. POMO PUERTA 125

código	acabado
1020001333	NEGRO



Mod. POMO PUERTA 125

código	acabado
1020003163	ANTICUARIO

13 estilo castellano



Mod. LLAMADOR 620	
código	descripción
1020001251	233x54 mm. NEGRO



Mod. LLAMADOR 622	
código	descripción
1020001252	233x54 mm. NEGRO



Mod. LLAMADOR 624	
código	descripción
1020001253	233x54 mm. NEGRO



Mod. LLAMADOR 624	
código	acabado
1020007968	233x54 mm. ANTICUARIO



Mod. MIRILLA 830	
código	descripción
1020001257	830 NEGRO 118x103 mm.
1020007191	830 ANTICUARIO 118x103 mm.



Mod. PASADOR 5	
código	descripción
1020001259	PASADOR 5 DE 15 NEGRO
1020001260	PASADOR 5 DE 20 NEGRO
1020001261	PASADOR 5 DE 25 NEGRO
1020001262	PASADOR 5 DE 30 NEGRO
1020001263	PASADOR 5 DE 40 NEGRO
1020001264	PASADOR 5 DE 50 NEGRO
1020001265	PASADOR 5 DE 60 NEGRO
1020003149	PASADOR 5 DE 15 ANTICUARIO
1020003150	PASADOR 5 DE 20 ANTICUARIO
1020003151	PASADOR 5 DE 25 ANTICUARIO
1020003152	PASADOR 5 DE 30 ANTICUARIO
1020003153	PASADOR 5 DE 40 ANTICUARIO
1020005784	PASADOR 5 DE 50 ANTICUARIO
1020006665	PASADOR 5 DE 70 ANTICUARIO



Mod. PASADOR 7	
código	descripción
1020005539	PASADOR 7 DE 15 NEGRO
1020001266	PASADOR 7 DE 20 NEGRO
1020001267	PASADOR 7 DE 25 NEGRO
1020001268	PASADOR 7 DE 30 NEGRO
1020001269	PASADOR 7 DE 40 NEGRO
1020001270	PASADOR 7 DE 50 NEGRO
1020001271	PASADOR 7 DE 60 NEGRO
1020001272	PASADOR 7 DE 70 NEGRO
1020001273	PASADOR 7 DE 80 NEGRO
1020003158	PASADOR 7 DE 25 ANTICUARIO
1020003159	PASADOR 7 DE 30 ANTICUARIO
1020003160	PASADOR 7 DE 40 ANTICUARIO
1020003161	PASADOR 7 DE 50 ANTICUARIO
1020003162	PASADOR 7 DE 70 ANTICUARIO
1020006014	PASADOR 7 DE 100 ANTICUARIO
1020007709	PASADOR 7 DE 30 PLATA VIEJA
1020007708	PASADOR 7 DE 50 PLATA VIEJA



Mod. PASADOR 85-R	
código	descripción
1020001237	220x45 mm. NEGRO
1020008544	220x45 mm. ANTICUARIO



Mod. PASADOR 45	
código	descripción
1020003600	CERROJO 45-P DE 120 NEGRO
1020003601	CERROJO 45 DE 160 NEGRO



Mod. PASADOR 84-R	
código	descripción
1020001232	84 R DE 40 NEGRO
1020001233	84 R DE 50 NEGRO
1020001234	84 R DE 60 NEGRO
1020001235	84 R DE 80 NEGRO
1020001236	84 R DE 100 NEGRO
1020003164	84 R DE 40 ANTICUARIO
1020008509	84 R DE 40 PLATA VIEJA

13 estilo castellano

Mod. PERNIO 402-T

código	descripción
1020003157	402T-80 DERECHA ANTICUARIO
1020003156	402T-80 IZQUIERDA ANTICUARIO
1020003154	402T-95 DERECHA ANTICUARIO
1020003155	402T-95 IZQUIERDA ANTICUARIO
1020006699	402T-80 DERECHA PLATA VIEJA
1020006700	402T-80 IZQUIERDA PLATA VIEJA
1020006697	402T-95 DERECHA PLATA VIEJA
1020006698	402T-95 IZQUIERDA PLATA VIEJA

Mod. BISAGRA ANTIPALANCA

código	descripción
1020007649	1540 150x80 mm. CANTO REDONDO ANTICUARIO
1020007642	1540 150x80 mm. CANTO REDONDO PLATA VIEJA
1020008693	483-R 150x80 mm. CANTO REDONDO NEGRO
1020005232	1530 150x80 mm. CANTO CUADRADO ANTICUARIO
1020008758	483 150x80 mm. CANTO CUADRADO NEGRO

Mod. PERNIO 403-T

código	descripción
1020001320	403T DE 80 DERECHA NEGRO
1020001315	403T DE 80 IZQUIERDA NEGRO
1020001321	403T DE 95 DERECHA NEGRO
1020001316	403T DE 95 IZQUIERDA NEGRO
1020001322	403T DE 110 DERECHA NEGRO
1020001317	403T DE 110 IZQUIERDA NEGRO

Mod. PERNIO 403-T ESCUADRA

código	descripción
1020001324	ESCUADRA DE 95 DERECHA NEGRO
1020001319	ESCUADRA DE 95 IZQUIERDA NEGRO

Mod. BISAGRA PORTÓN 700

código	descripción
1020006019	153x170 mm. NEGRO

Mod. BISAGRA PORTÓN 705

código	descripción
1020003526	153x305 mm. NEGRO

Mod. BISAGRA PORTÓN 710

código	descripción
1020001231	153x445 mm. NEGRO

Mod. BISAGRA 50

código	descripción
1010000822	110x245 mm. NEGRO



Mod. BISAGRA 55	
código	descripción
1010000824	55 (92x180 mm.) NEGRO
1010000823	55-P (80x150 mm.) NEGRO



Mod. BISAGRA 60	
código	descripción
1010000826	60 (92x40 mm.) NEGRO
1010000825	60-P (80x32 mm.) NEGRO
1020004514	60 (92x40 mm.) ANTICUARIO



Mod. CLAVO REDONDO LISO	
código	descripción
1020005872	19 DE 30 ANTICUARIO
1020007141	19 DE 30 PLATA VIEJA
1020007005	19 DE 40 PLATA VIEJA
1020004067	REDONDO DE 25 NEGRO
1020001204	REDONDO DE 30 NEGRO
1020001205	REDONDO DE 35 NEGRO
1020005130	REDONDO DE 40 NEGRO



Mod. CLAVO REDONDO MARTILLEADO	
código	descripción
1020006558	18 DE 30 ANTICUARIO
1020007013	18 DE 40 ANTICUARIO



Mod. CLAVO 21	
código	descripción
1020001240	21 DE 25 NEGRO
1020001241	21 DE 30 NEGRO
1020001242	21 DE 40 NEGRO
1020005978	21 DE 30 ANTICUARIO

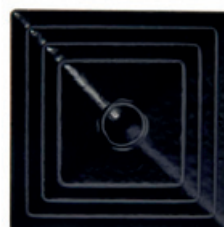

Mod. 26 DE 30 NEGRO	
código	acabado
1020001244	NEGRO



Mod. CREMONA 1010	
código	descripción
1020008024	CREMONA ESE 1010 NEGRO
1020008025	CREMONA ESE 1010 ANTICUARIO
1020008029	VARILLA 850 DE 1500 mm. ANTICUARIO
1020008026	VARILLA 850 DE 1500 mm. NEGRO

13 estilo castellano

Mod. PICAPORTE 271-C

código	descripción
1020001327	271-C DE 4' NEGRO
1020001328	271-C DE 5' NEGRO

Mod. FALLEBA ESPAÑOLETA

código	descripción
1020003418	FALLEBA NEGRO
1020002310	VARILLA
1020003434	GANCHO

Mod. GOLFO VENTANA 24-C DE 250

código	acabado
1020001250	NEGRO

Mod. ALDABILLA 23-M

código	descripción
1020001229	23-M DERECHA NEGRO
1020001230	23-M. IZQUIERDA NEGRO
1020004255	23-M DERECHA ANTICUARIO
1020004256	23-M IZQUIERDA ANTICUARIO

Mod. CIERRE DE PRESIÓN 660

código	acabado
1020001238	FII 660 NEGRO DERECHA
1020001239	FII 660 NEGRO IZQUIERDA

Mod. RETENIDA ESE 25-E

código	descripción
1020006517	ESE 25-E ANTICUARIO
1020004446	ESE 25-E NEGRO

Mod. RETENIDA ESE 25-T NEGRO

código	acabado
1020001248	NEGRO

Mod. SOPORTE PALOMILLA 4

código	descripción
1020008917	150x125 NEGRO
1020008669	200x150 NEGRO
1020008670	250x200 NEGRO



Mod. ESCUADRA 70

código	descripción
1010000829	70 (160x160 mm.) NEGRO
1020001246	70-P (130x130 mm.) NEGRO



Mod. POMO 500

código	descripción
1010000832	24 mm. NEGRO



Mod. TIRADOR ARMARIO 30

código	descripción
1010000841	SIN BOCALLAVE NEGRO
1010000842	CON BOCALLAVE NEGRO
1010002770	CON BOCALLAVE ANTICUARIO
1010002771	SIN BOCALLAVE ANTICUARIO



Mod. TIRADOR MALETERO 28

código	descripción
1010002769	TIRADOR 28 ANTICUARIO
1010002678	TIRADOR 28 NEGRO



Mod. TIRADOR PÉNDULO 75

código	descripción
1010000840	90X38 mm. NEGRO
1010000839	80X30 mm. NEGRO
1010005959	90X38 mm. ANTICUARIO



Mod. TIRADOR PÉNDULO 80

código	descripción
1010000845	80 38x90 mm. NEGRO
1020001338	80-P 30x80 mm. NEGRO
1010005958	80 38x90 mm. ANTICUARIO



Mod. TIRADOR ANILLA 75-A

código	descripción
1010000834	75-A 90X38 mm. NEGRO
1010000838	75P-A 80X30 mm. NEGRO
1010004565	75P-A 90X38 mm. ANTICUARIO



Mod. TIRADOR ANILLA 80-A

código	descripción
1020001340	80-A 38x90 mm. NEGRO
1020001339	80P-A 30x80 mm. NEGRO
1020008670	250x200 mm. NEGRO

13 estilo castellano



BOCALLAVE 90-H

código	descripción
1010000831	65x27 mm, NEGRO



BOCALLAVE 90-H

código	descripción
1010000830	65x27 mm, NEGRO



Mod. CIERRE ARCON 55-A NEGRO

código	descripción
1010000828	55-A 180x92 mm, NEGRO
1010000827	55P-A 150x80 mm, NEGRO



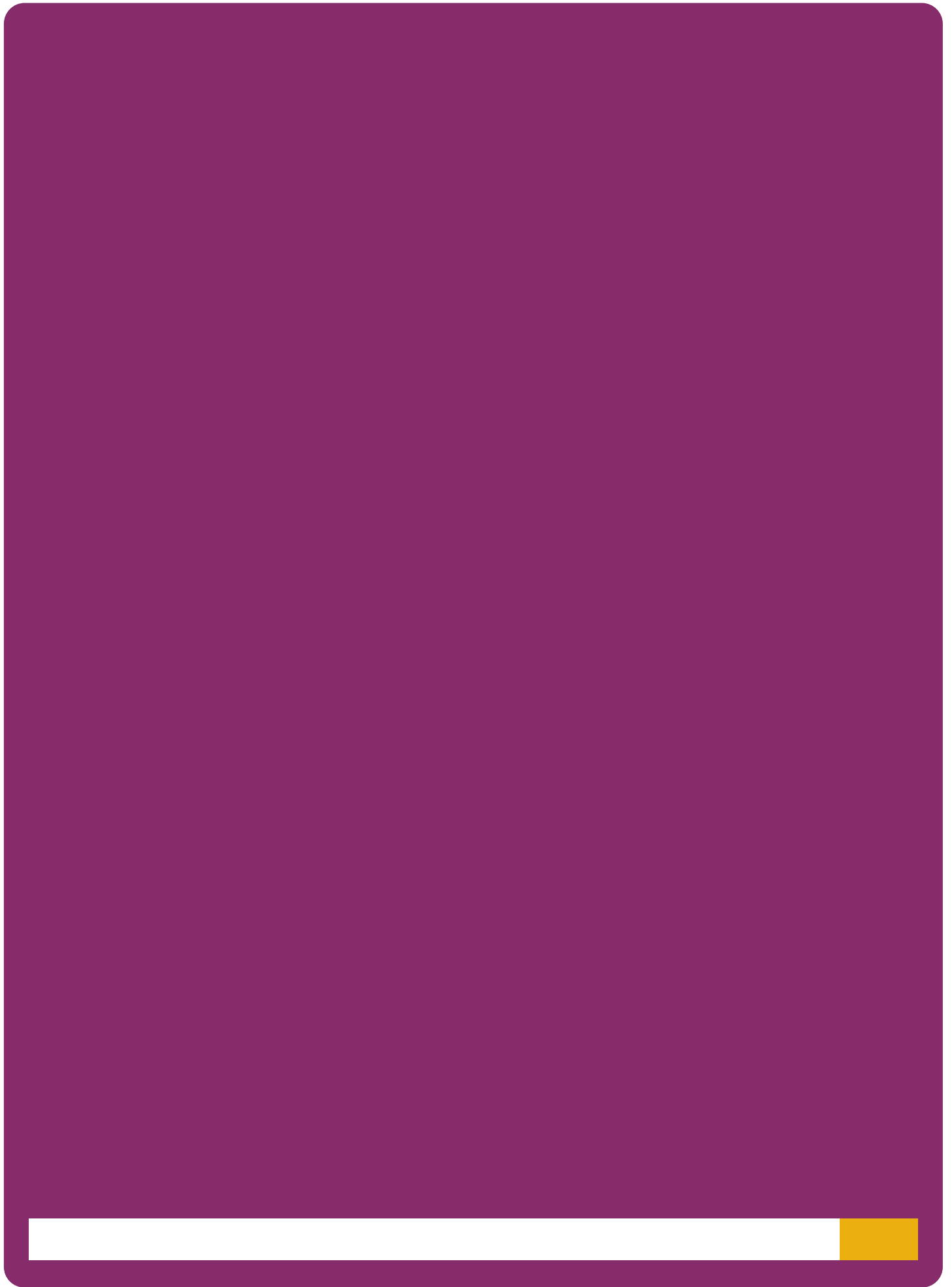

IG3

herrajes para el mueble

01	guías correderas y cajones	96
02	bisagras	99
03	compases y pistones	105
04	vaivenes y cierres	106
05	cerraduras	109
06	pasadores	112
07	sistemas de unión	112
08	soporte estantes	116
09	varios	117
10	tiradores	121





GUÍA OCULTA EXTRACCIÓN TOTAL CON ENGANCHE

código	descripción
	Con freno y amortiguador. Capacidad de carga 30 Kgrs.
1010009434	GUÍA 300 mm.
1010009435	GUÍA 350 mm.
1010009436	GUÍA 400 mm.
1010009437	GUÍA 450 mm.
1010009438	GUÍA 500 mm.
1010009439	GUÍA 550 mm.



GUÍA OCULTA EXTRACCIÓN TOTAL

código	descripción
	Autocierre y amortiguador. Capacidad de carga por juego de hasta 25 kg.
1010009082	GUÍA 350 mm.
1010009083	GUÍA 400 mm.
1010009122	GUÍA 450 mm.
1010009094	GUÍA 500 mm.
1010009133	GUÍA 550 mm.



GUÍA OCULTA EXTRACCIÓN PARCIAL

código	acabado
	Autocierre y amortiguador Capacidad de carga por juego de hasta 25 kg.
1010007854	GUÍA 4102505 290 mm.
1010007858	GUÍA 4102605 340 mm.



GUÍA OCULTA PUSH

código	descripción
	Extracción parcial. Sistema de expulsión al presionar el cajón. Capacidad de carga por juego de hasta 25 kg.
1010008392	GUÍA PUSH 4103005 240 mm.
1010008393	GUÍA PUSH 4103105 290 mm.
1010008391	GUÍA PUSH 4103205 340 mm.
1010008728	GUÍA PUSH 4103305 390 mm.
1010008390	GUÍA PUSH 4103405 440 mm.
1010008394	GUÍA PUSH 4103505 490 mm.

01 guías y cajones

GUÍA DE BOLAS EXTRACCIÓN TOTAL

código	descripción
	De 47 mm. de altura
1010009126	GUÍA 250 mm.
1010008750	GUÍA 300 mm.
1010008773	GUÍA 350 mm.
1010008642	GUÍA 400 mm.
1010008641	GUÍA 450 mm.
1010008458	GUÍA 500 mm.
1010007896	GUÍA 550 mm.
1010007900	GUÍA 600 mm.
1010007836	GUÍA 700 mm.
1010007837	GUÍA 800 mm.
1010008643	GUÍA 1000 mm.

GUÍA DE BOLAS EXTRACCIÓN PARCIAL

código	descripción
	De 17 mm. de altura
1010008258	GUÍA 188 mm.
1010008133	GUÍA 214 mm.
1010008204	GUÍA 246 mm.
1010008257	GUÍA 278 mm.
1010008134	GUÍA 310 mm.
1010008639	GUÍA 342 mm.
1010008644	GUÍA 438 mm.

GUÍA RODILLO NYLON CON CAIDA

código	descripción		
	Emparejadas.		
1010006981	GUÍA 250 mm. BLANCO	1010005541	GUÍA 400 mm. BLANCO
1010008771	GUÍA 250 mm. MARRÓN	1010005733	GUÍA 400 mm. MARRÓN
1010005645	GUÍA 270 mm. BLANCO	1010006600	GUÍA 450 mm. GRIS
1010005904	GUÍA 270 mm. MARRÓN	1010005542	GUÍA 450 mm. BLANCO
1010008624	GUÍA 300 mm. GRIS	1010005641	GUÍA 450 mm. MARRÓN
1010005640	GUÍA 300 mm. BLANCO	1010004601	GUÍA 450 mm. MARRÓN
1010005569	GUÍA 300 mm. MARRÓN	1010006601	GUÍA 500 mm. GRIS
1010006218	GUÍA 350 mm. GRIS	1010005639	GUÍA 500 mm. BLANCO
1010005632	GUÍA 350 mm. BLANCO	1010005608	GUÍA 500 mm. MARRÓN
1010005550	GUÍA 350 mm. MARRÓN	1010006602	GUÍA 550 mm. GRIS
1010006599	GUÍA 400 mm. GRIS	1010005598	GUÍA 550 mm. BLANCO
		1010005580	GUÍA 550 mm. MARRÓN
		1010006603	GUÍA 600 mm. GRIS
		1010005570	GUÍA 600 mm. BLANCO
		1010005568	GUÍA 600 mm. MARRÓN



CAJÓN TANDEMBOX

código	descripción
	Con extracción total oculta y controlada. Tandem Inside para el deslizamiento ligero durante toda la vida del mueble. Montaje del frontal sin herramientas. Con BLUMOTION integrado para lograr que los cajones se cierren de forma silenciosa. Posibilidad de combinarse con SERVODRIVE. Acabado color Gris.
1010009158	358M2700SA-F 270 mm.
1010008858	358M3502SA-F 350 mm.
1010008802	358M4002SA-F 400 mm.
1010008782	358M4502SA-F 450 mm.
1010008786	358M5002SA-F 500 mm.

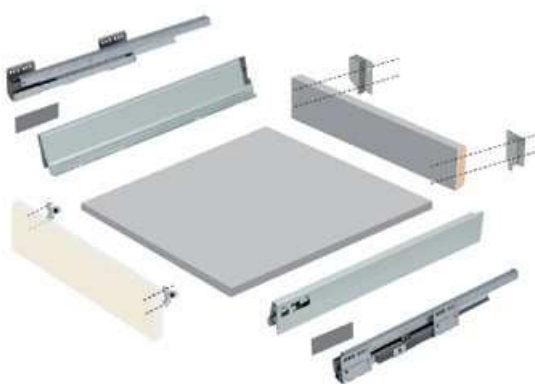

CAJÓN VANTAGE

código	descripción
	Extracción total con freno y amortiguador. Acabado color gris
1010008142	4194525 83x500 mm.



CAJÓN SOFTBOX

código	descripción
	Extracción total con freno y amortiguador. Acabado color Gris
1010009414	KIT SOFTBOX HP/180 350 mm.
1010009415	KIT SOFTBOX HP/180 400 mm.
1010009416	KIT SOFTBOX HP/180 450 mm.
1010008588	KIT SOFTBOX HP/180 500 mm.



CAJÓN UNISSET

código	descripción
1010005914	85x270 mm. BLANCO
1010005965	85x270 mm. GRIS
1010006356	85x350 mm. BLANCO
1010006359	85x350 mm. GRIS
1010006054	85x400 mm. BLANCO
1010005903	85x400 mm. GRIS
1010006062	85x450 mm. BLANCO
1010006063	85x450 mm. GRIS
1010005981	85x500 mm. BLANCO
1010005911	85x500 mm. GRIS
1010006065	117x270 mm. BLANCO
1010005976	117x270 mm. GRIS
1010006064	117x350 mm. BLANCO
1010006358	117x350 mm. GRIS
1010005867	117x400 mm. BLANCO
1010006076	117x400 mm. GRIS
1010005868	117x450 mm. BLANCO
1010005869	117x450 mm. GRIS
1010005915	117x500 mm. BLANCO
1010005912	117x500 mm. GRIS

02 bisagras

BISAGRA 494

código	descripción
1020009010	60x40x1,5 mm. INOX
1020009009	70x50x1,5 mm. INOX

BISAGRA 495

código	descripción
1020005979	60x40x1,5 mm. DERECHA INOX
1020005980	60x40x1,5 mm. IZQUIERDA INOX
1020008670	250x200 mm. NEGRO

BISAGRA 458

código	descripción
1010005392	60X40x1,5 mm. INOX
1020009048	70X50x1,5 mm. INOX

BISAGRA 277

código	descripción
1020005915	70X50x1,5 mm. DERECHA INOX
1020005916	70X50x1,5 mm. IZQUIERDA INOX

BISAGRA DE LATÓN LAMINADO MOD. 1006

código	descripción
1020000141	1006 50x40x2 mm. DERECHA LATÓN BRILLO
1020003767	1006 50x40x2 mm. IZQUIERDA LATÓN BRILLO
1020008080	462 60X40x2 mm. DERECHA LATÓN SATINADO
1020008081	462 60X40x2 mm. IZQUIERDA LATÓN SATINADO
1020008082	462 70X50x2 mm. DERECHA LATÓN SATINADO
1020008169	462 70X50x2 mm. IZQUIERDA LATÓN SATINADO
1020000153	1006 60x40x2 mm. DERECHA CROMO
1020000145	1006 60x40x2 mm. IZQUIERDA CROMO

1020005514	1006 60x40x2 mm. DERECHA CROMO MATE
1020005515	1006 60x40x2 mm. IZQUIERDA CROMO MATE
1020005386	1006 60x40x2 mm. DERECHA CUERO
1020005387	1006 60x40x2 mm. IZQUIERDA CUERO
1020000154	1006 70x50x2 mm. DERECHA CROMO
1020000146	1006 70x50x2 mm. IZQUIERDA CROMO
1020005640	1006 70x50x2 mm. DERECHA CROMO MATE
1020005641	1006 70x50x2 mm. IZQUIERDA CROMO MATE
1020005384	1006 70x50x2 mm. DERECHA CUERO
1020005385	1006 70x50x2 mm. IZQUIERDA CUERO

BISAGRA 304

código	descripción
1010005728	30x80 mm. LATÓN SATINADO

BISAGRA FIJA DE HIERRO MOD. 207 REMATE CHATO

código	descripción
1010002037	25x25 mm. LATONADO



BISAGRA FIJA DE HIERRO MOD.207

código	descripción
	Canto cuadrado.
1010002041	25x25 mm. LATONADO
1010002042	40x35 mm. LATONADO
1010002031	40x35 mm. CUERO
1010002043	50x35 mm. LATONADO
1010002044	50x40 mm. LATONADO
1010002104	60x40 mm. LATONADO
1010002032	60x40 mm. CUERO
1010002056	60x40 mm. NIQUEL
1010002048	70x40 mm. LATONADO

1010006838	70x40 mm. CUERO
1010002049	70x50 mm. LATONADO
1010002033	70x50 mm. CUERO
1010005095	70x50 mm. NIQUEL
1010002050	80x60 mm. LATONADO
	Canto redondo
1010002039	60x40 mm. LATONADO
1010002034	60x40 mm. CUERO
1010007738	60x40 mm. NIQUEL
1010002040	70x50 mm. LATONADO
1010002036	70x50 mm. CUERO
	Con tapabocas
1010002035	60x40 mm. CUERO



BISAGRA FIJA SOLAPADA DE HIERRO MOD.105

código	descripción
1010002077	105 60x40x17 LATONADO
1010006967	105 60x40x17 NIQUEL
1010002078	105 60x45x19 LATONADO
1010002079	105 60x50x22 LATONADO
1010002080	105 70x45x19 LATONADO
1010006130	105 70x45x19 CUERO
1010006354	105 70x45x19 NIQUEL
1010002081	105 70x50x22 LATONADO



BISAGRA DESMONTABLE DE HIERRO MOD.210

código	acabado
	Canto cuadrado
1010002069	210 60x40 mm. LATONADO
1010002071	210 70x50 mm. LATONADO
	Canto redondo
1010002074	210 60x40 mm. LATONADO
1010002063	210 60x40 mm. CUERO
1010002076	210 70x50 mm. LATONADO
1010002064	210 70x50 mm. CUERO



BISAGRA DE HIERRO MOD. 541

código	descripción
1010000184	50x40x1,2 mm. DERECHA LATONADO
1010000178	50x40x1,2 mm. IZQUIERDA LATONADO
1010000185	60x40x1,2 mm. DERECHA LATONADO
1010000179	60x40x1,2 mm. IZQUIERDA LATONADO
1010000186	60x40x1,2 mm. DERECHA NEGRO
1010000180	60x40x1,2 mm. IZQUIERDA NEGRO
1010000187	70x50x1,2 mm. DERECHA LATONADO
1010000181	70x50x1,2 mm. IZQUIERDA LATONADO
1010000188	70x50x1,2 mm. DERECHA NEGRO
1010000182	70x50x1,2 mm. IZQUIERDA NEGRO
1010000189	80x50x1,2 mm. DERECHA LATONADO
1010000183	80x50x1,2 mm. IZQUIERDA LATONADO

02 bisagras



BISAGRA INGLESA 170

código	acabado
1010002107	CUERO

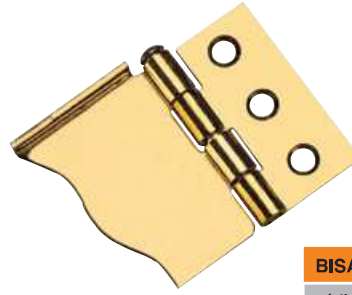

BISAGRA DE HIERRO MOD.10

código	descripción
1020004439	10 DERECHA LATONADO
1020004874	10 IZQUIERDA LATONADO



BISAGRA DE HIERRO MOD. 5005

código	descripción
1010002090	5005 1' PULIDO
1010002092	5005 1-1/2' PULIDO
1010002091	5005 1-1/4' PULIDO
1010002093	5005 1-3/4' PULIDO
1010002094	5005 2' 50X30 PULIDO
1010002096	5005 2-1/2' PULIDO
1010002095	5005 2-1/4' PULIDO
1010002097	5005 3' PULIDO
1010002089	5005 3/4' PULIDO



BISAGRA PARA BIOMBO 126

código	descripción
1010002098	126 BIOMBO 60x30 mm. LATONADO

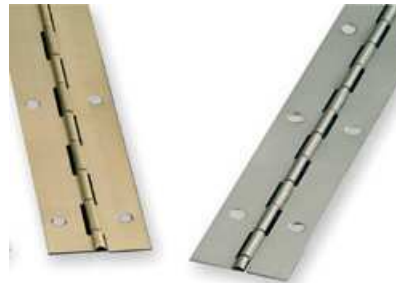

BISAGRA DE PIANO

código	acabado
1010003420	LATONADO
1010006520	NIQUELADO





BISAGRA 1115

código	descripción
1010004072	1115 32 mm. CUERO
1010006582	1115 32 mm. CON REGULACIÓN CUERO
1010005443	1115 32 mm. CON REGULACIÓN CROMO MATE



BISAGRA 1121

código	descripción
1010004628	1121 26 mm. CUERO
1010004627	1121 26 mm. CROMO MATE



BISAGRA 1123

código	descripción
1010004630	1123 26 mm. CUERO



BISAGRA 1113

código	descripción
1010000919	1113 35 mm. CUERO



BISAGRA 1131

código	descripción
1010004634	1131 35 mm. CUERO
1010004873	1131 35 mm. CROMO MATE



BISAGRA 1140

código	descripción
1010006167	1140 35 mm. CUERO



BISAGRA 1141

código	descripción
1010006330	1141 35 mm. CUERO



BISAGRA 1142

código	descripción
1010006473	1142 35 mm. CUERO

02 bisagras

BISAGRA 1143

código	descripción
1010006327	1143 35 mm. CROMO MATE
1010006324	1143 35 mm. PLATA VIEJA
1010006259	1143 35 mm. CUERO

BISAGRA 471

código	descripción
1010001437	471 CROMO 94 mm. IBYP
1010001438	471 CUERO 94 mm. IBYP

BISAGRA 470

código	descripción
1010001433	470 CUERO 79 mm. IBYP

BISAGRA 521

código	descripción
1010001442	521 CUERO 99 mm. IBYP
1010001443	521 LATÓN 99 mm. IBYP

BISAGRA 860

código	descripción
1010001444	860 CUERO 99 mm. IBYP

PERNIO TIPO ANUBA

código	descripción
	Con remate
1020006427	9 mm. CUERO
1020003173	E00132.09.03 9 mm. HIERRO LATONADO
1020003179	E00132.09.09 9 mm. NEGRO
1020003171	E00131.11.02 11 mm. CUERO
1020003174	E00131.11.03 11 mm. HIERRO LATONADO
1020003180	E00131.11.09 11 mm. NEGRO

1020003172	E00132.13.02 13 mm. CUERO
1020003175	E00132.13.03 13 mm. HIERRO LATONADO
1020003181	E00132.13.09 13 mm. NEGRO
	Sin remate
1020003185	E00119.09.03 9 mm. HIERRO LATONADO
1020005015	E00119.11.34 11 mm. CROMO MATE
1020003187	E00118.13.03 13 mm. HIERRO LATONADO
1020005016	E00118.13.34 13 mm. CROMO MATE

**BISAGRA OCULTA**

código	descripción
101000657	REDONDA DE 10 mm. LATÓN
101000659	REDONDA DE 12 mm. LATÓN
1010002859	OVALADA DE 12 mm. ZAMAK
1010002860	REDONDA DE 14 mm. ZAMAK
1010002856	REDONDA DE 14 mm. PVC COLOR ROBLE
1010005125	REDONDA DE 12 mm. PVC COLOR ROBLE

**BISAGRA OCULTA HP5950**

código	descripción
1020008392	44x12'7 mm. 10 Kgr. NÍQUEL SATINADO

**BISAGRA AUTOMÁTICA 415**

código	acabado
1020009197	NÍQUEL

**BISAGRA DE CAZOLETA 26 mm.**

código	descripción
1010009003	41-M RECTA + BASE
1010006333	1240007 ACODADA
1010009004	43-M SUPER ACODADA+BASE
1010006335	BASE CRUZ 1241607 PARA BISAGRA ACODADA

**BISAGRA DE CAZOLETA 35 mm.**

código	descripción
1010009413	RECTA+BASE
1010009093	ACODADA+BASE
1010009011	SUPER ACODADA+BASE

**BISAGRA DE PROLONGACIÓN 12369**

código	descripción
1010005165	CAZOLETA DE 35 mm.
	Incluye base

**BISAGRA DE BRAZO CORTO CAZOLETA DE 35mm**

código	descripción
1010005100	RECTA+BASE
1010003595	ACODADA+BASE
1010008333	DE PROLONGACIÓN Ref. 342806063
1010008334	BASE PROLONGACIÓN Ref. 347602065

02 bisagras



BISAGRA PARA PUERTA DE CRISTAL 1205064

código	acabado
1010009267	CROMO MATE

BISAGRA CENTRAL PARA PUERTA DE CRISTAL 1205164

código	acabado
1010005551	CROMO MATE

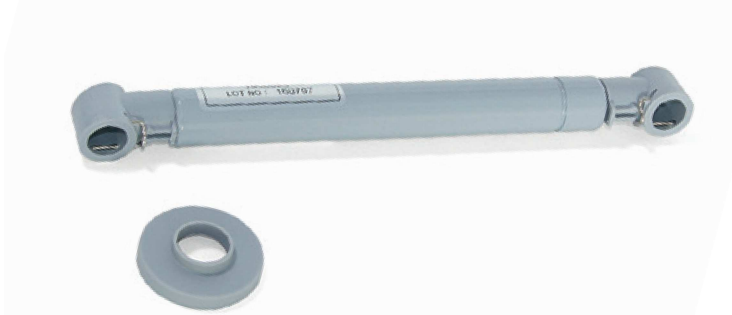
03 compases y pistones

PISTÓN AMORTIGUADOR ABATIBLE

código	descripción
1010005603	PISTÓN 12442 6 Kg. GRIS

PISTÓN AMORTIGUADOR ELEVABLE CALIDAD EXTRA

código	descripción
1010006217	PISTÓN ELEVABLE CORTO 12638 5Kg. GRIS
1010005860	PISTÓN ELEVABLE 12357 5 Kg. GRIS
1010005863	PISTÓN ELEVABLE 12278 8 Kg. GRIS
1010005861	PISTÓN ELEVABLE 12279 11 Kg. GRIS
1010006039	PISTÓN ELEVABLE 12448 20 Kg. GRIS

ENGANCHE LATERAL 12280

código	acabado
1010003707	NÍQUEL

ENGANCHE PARA PUERTA ALUMINIO 12324

código	acabado
1010004039	NÍQUEL

ENGANCHE PARA PUERTA DE MADERA 12281

código	acabado
1010003706	NÍQUEL

**PISTÓN AMORTIGUADOR GAMA BÁSICA**

código	descripción
1010008723	PISTÓN CORTO A-632-5 5 Kg GRIS
1010009159	PISTÓN G2002/60 6 Kg GRIS
1010009087	PISTÓN A-630-8 8 Kg GRIS
1010009160	PISTÓN G2002/80 8 Kg GRIS
1010009088	PISTÓN A-630-12 12 Kg GRIS

**COMPAS ABATIBLE SDS**

código	descripción
	Incorpora autocierre, Ángulo apertura regulable. 5-12 Kg.
1010006211	SDS 1000717 NEGRO

**COMPÁS FRENO**

código	descripción
1010004068	101.50.0 250 mm, NÍQUEL
1010000860	101.50.1 250 mm. LATONADO

**COMPÁS DUO FORTE ELEVABLE/ABATIBLE**

código	descripción
1010005520	373.66.631 NÍQUEL

**COMPÁS ELEVABLE NSDX**

código	descripción
	Mínimo altura de puerta recomendada de 300 mm. Se puede regular la velocidad de bajada de la puerta mediante un tornillo.
1010003471	NSDX-L 12340 IZQUIERDA
1010003472	NSDX-R 12341 DERECHA
1010003473	ENGANCHE PARA NSDX 123421

**COMPÁS ABATIBLE A-476**

código	descripción
1010008288	A-476-10 LATONADO
1010007877	A-476-12 CROMO
1010007914	A-476-78 CUERO

**COMPÁS CURVO**

código	descripción
1010005865	1691220 120 mm. DERECHA LATONADO
1010005866	1691220 120 mm. IZQUIERDA LATONADO

04 vaivenes y cierres



VAIVÉN SILENCIOSO RODILLO DE GOMA ERLE

código	acabado
1010000893	103.20.0 ZINCADO
1010000895	103.20.2 BICROMATIZADO
1010000894	103.20.1 LATONADO
1010006177	103.20.3 BRONCE



VAIVÉN RODILLO DE GOMA 12 AMIG

código	acabado
1010000216	BICROMATIZADO
1010003623	BRONCE



VAIVÉN RODILLO NYLON 16

código	acabado
1010000220	BICROMATIZADO

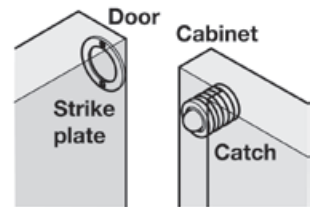

VAIVÉN DE BOLA EMBUTIR ROSCA

código	descripción
1010001178	241.86.114 12 mm.



VAIVÉN DE BOLA EMBUTIR A PRESIÓN

código	descripción
1010001177	241.80.514 8 mm.



GOLPETE DE LATÓN 104

código	descripción
1020004817	43 mm. LATÓN SATINADO
1020004974	50 mm. LATÓN SATINADO
1020004660	50 mm. LATÓN CROMADO



CIERRE IMÁN	
código	descripción
1020009213	200 de 46x15 mm. BLANCO
1020009152	200 de 46x15 mm. MARRÓN
1020004998	102 de 58x15 mm. BLANCO
1020004966	102 de 58x15 mm. MARRÓN



CIERRE MAGNÉTICO 13152	
código	acabado
1010005646	MARRÓN



CIERRE MAGNÉTICO CI68084	
código	acabado
1010003028	NEGRO



CIERRE MAGNÉTICO CI64082	
código	acabado
1010008050	MARRÓN



CIERRE MAGNÉTICO	
código	acabado
1010008561	642281 BLANCO
1010005660	642282 MARRÓN



CIERRE MAGNÉTICO EMBUTIR 634-84	
código	acabado
1010000669	NEGRO



CIERRE MAGNÉTICO PUSH	
código	descripción
1010006475	2033121 40,5x16,5 mm. GRIS
1010005540	2033921 62x16,5 mm. GRIS



CIERRE FAST LATCH	
código	acabado
1010004070	90075 BLANCO
1010005311	90075 MARRÓN



CIERRE LATCH CI18002	
código	acabado
1010000666	LATONADO

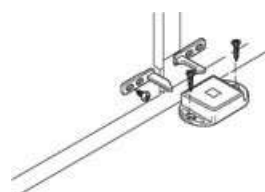

CIERRE AUTOMÁTICO 245.58.754	
código	acabado
1010006909	NIQUEL

05 cerraduras

CERRADURA DE EMBUTIR 205-A

código	descripción
1010003047	205-A de 10 mm.
1010001240	205-A de 15 mm.
1010001241	205-A de 20 mm.
1010001242	205-A de 25 mm.
1010001243	205-A de 30 mm.
1010001244	205-A de 35 mm.
1010001245	205-A de 40 mm.
1010001246	205-A de 50 mm.
1010001247	205-A de 60 mm.

CERRADURA DE EMBUTIR 205-AR

código	descripción
1010001248	205-AR de 15 mm. CANTO REDONDO
1010001249	205-AR de 20 mm. CANTO REDONDO
1010001250	205-AR de 25 mm. CANTO REDONDO
1010001251	205-AR de 30 mm. CANTO REDONDO
1010001252	205-AR de 35 mm. CANTO REDONDO

CERRADURA DE EMBUTIR 205-E

código	descripción
1010001254	205-E de 20 mm.
1010001255	205-E de 25 mm.
1010001256	205-E de 30 mm.
1010001257	205-E de 35 mm.
1010001258	205-E de 40 mm.



CERRADURA DE EMBUTIR 205-ER

código	descripción
1010001261	205-ER de 20 mm. CANTO REDONDO
1010001262	205-ER de 25 mm. CANTO REDONDO
1010003046	205-ER de 30 mm. CANTO REDONDO
1010001251	205-AR de 30 mm. CANTO REDONDO

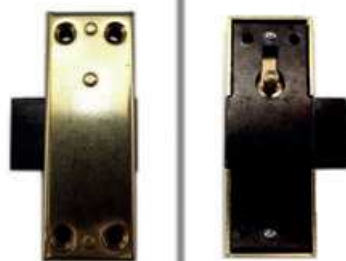

CERRADURA 206-A

código	descripción
1010001275	206-A de 30 mm.
1010001276	206-A de 35 mm.



CERRADURA DE SOBREPONER 108-A

código	descripción
1010001239	108-A de 11 mm. LATONADO



CERRADURA DE SOBREPONER 307-A

código	descripción
1010001265	307-A de 20 mm. LATONADA
1010001266	307-A de 25 mm. LATONADA
1010001267	307-A de 30 mm. LATONADA



CERRADURA DE SOBREPONER 23-R

código	descripción
1010003516	23-R DE 20 mm. LATONADO
1010002194	23-R DE 25 mm. LATONADO
1010002196	23-R DE 30 mm. LATONADO
1010002197	23-R DE 35 mm. LATONADO
1010002195	23-R DE 25 mm. BOMBILLO DE 25 mm. LATONADO
1010002803	23-R DE 30 mm. BOMBILLO DE 25 mm. LATONADO
1010004557	23-R DE 30 mm. BOMBILLO DE 35 mm. LATONADO
1010005693	23-RNM DE 25 mm. NÍQUEL SATINADO
1010005694	23-RNM DE 30 mm. NÍQUEL SATINADO
1010008928	23-RNM DE 35 mm. NÍQUEL SATINADO
1010005695	23-RNM DE 25 mm. BOMBILLO DE 25 mm. NÍQUEL SATINADO
1010005696	23-RNM DE 30 mm. BOMBILLO DE 25 mm. NÍQUEL SATINADO
1010005697	23-R DE 25 mm. BOMBILLO DE 35 mm. NÍQUEL SATINADO
1010005698	23-R DE 30 mm. BOMBILLO DE 35 mm. NÍQUEL SATINADO
1010008502	23-R DE 35 mm. BOMBILLO DE 35 mm. NÍQUEL SATINADO

05 cerraduras



CERRADURA DE SOBREPONER SYMO

código	descripción
	Distancia regulable al centro de 15 a 40 mm.
1010006999	CERRADURA 232.26.690 NÍQUEL
1010006996	CILINDRO 210.40.600 NÍQUEL
1010006998	ROSETA PARA CILINDRO 219.19.677 NÍQUEL



CERRADURA CAJON CM13822C

código	acabado
1010000663	NÍQUEL



CERRADURA 5003 CUERO

código	acabado
1010003498	CUERO



CERRADURA 301 CUERO

código	acabado
1010003759	CUERO



FALLEBA 5020

código	acabado
1010000701	CUERO



FALLEBA 5600

código	acabado
1010002995	CUERO

**PASADOR 368**

código	descripción
1010000226	60 mm. LATONADO
1010000227	80 mm. LATONADO
1010000224	100 mm. LATONADO
1010000225	120 mm. LATONADO

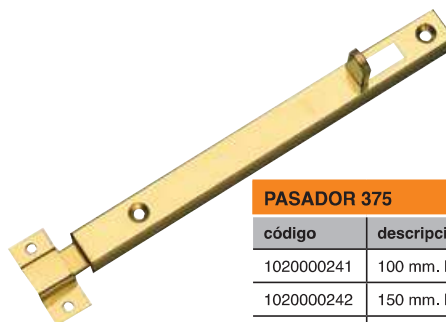
**PASADOR 375**

código	descripción
1020000241	100 mm. LATONADO
1020000242	150 mm. LATONADO
1020000243	200 mm. LATONADO
1020000244	250 mm. LATONADO

**PASADOR AUTOMÁTICO 103.43**

código	acabado
1010000873	103.43.0 NÍQUEL
1010000874	103.43.1 LATONADO

**PASADOR AUTOMÁTICO 103.44**

código	acabado
1010000875	103.44.0 NÍQUEL
1010000876	103.44.1 LATONADO

**HERRAJE ENSAMBLAR 102.00.4**

código	acabado
1010000870	BICRO

**HERRAJE ENSAMBLAR 102.05.0**

código	acabado
1010000871	BICRO

**TORNILLO ENSAMBLE 102.02.0**

código	acabado
1010000884	BICRO

**TORNILLO ENSAMBLE 102.03.0 CASCABEL**

código	acabado
1010000885	BICRO

**TORNILLO ENSAMBLE 102.03.1 ALLEN**

código	acabado
1010000886	BICRO

**TORNILLO ENSAMBLE 102.04.2 45 mm.**

código	acabado
1010000887	BICRO

07 sistemas de unión

ENSAMBLE 4004

código	acabado
1010006984	CUERO

ENSAMBLE KEKU

código	descripción
1010007889	ENSAMBLE TABLERO 262.50.359

ENSAMBLE KEKU

código	descripción
1010007855	CONTRAPIEZA KEKU 262.50.368

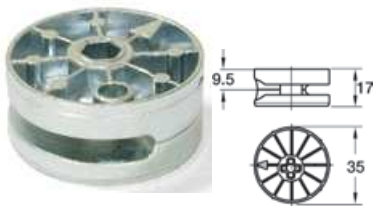
HERRAJE MAXIFIX

código	descripción
1010002840	EXCÉNTRICA MAXIFIX 262.86.703

HERRAJE MAXIFIX

código	descripción
1010001155	PERNO MAXIFIX 262.86.912

HERRAJE MAXIFIX

código	descripción
1010004301	TUERCA EMBUTIR 030.10.584 M8

HERRAJE MINI FIX

código	descripción
1010008495	EXCÉNTRICA MINI FIX 262.25.614 16mm

HERRAJE MINI FIX

código	descripción
1010005123	EXCÉNTRICA MINI FIX 262.26.173 16mm

HERRAJE MINI FIX

código	descripción
1010001156	PERNO MINIFIX 262.27.047 24mm

HERRAJE MINI FIX

código	descripción
1010001157	PERNO MINIFIX 262.27.921 16 24mm

HERRAJE MINI FIX

código	descripción
1010001159	PERNO MINIFIX 262.28.928 15 34mm

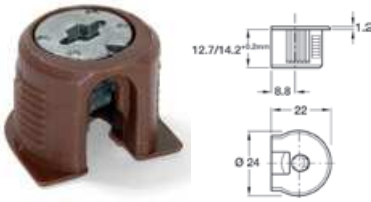
**HERRAJE RAFIX**

código	descripción
1010002900	EXCÉNTRICA RAFIX 263.10.103 MARRÓN

**HERRAJE RAFIX**

código	descripción
1010006825	EXCÉNTRICA RAFIX 263.15.703 NIQUEL

**HERRAJE RAFIX**

código	descripción
1010006479	EXCÉNTRICA RAFIX 263.13.705 NIQUEL

**HERRAJE RAFIX**

código	descripción
1010001160	PERNO RAFIX 263.20.141

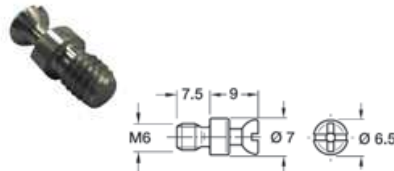
**HERRAJE RAFIX**

código	descripción
1010001161	PERNO RAFIX 263.21.120

**HERRAJE RAFIX**

código	descripción
1010006480	PERNO DOBLE RAFIX 263.24.943 22 mm.

**HERRAJE RAFIX**

código	descripción
1010007088	TUERCA 039.33.364 M6
1010001169	TUERCA 039.33.266 T=10/11

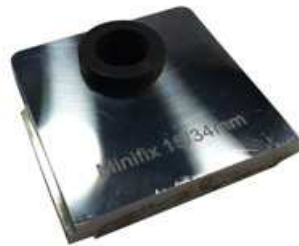
**PLANTILLAS**

código	descripción
1090000821	PLANTILLA MINIFIX 001.25.022 24 mm.
1090000820	PLANTILLA MINIFIX 001.25.023 34 mm.

**PLANTILLAS**

código	descripción
1090000822	PLANTILLA RAFIX 001.25.024

**PLANTILLAS**

código	descripción
1090000819	PLANTILLA 001.25.000 UNITOOL-MULTI

**UNIÓN ANGULAR GRANDE**

código	descripción
1010001170	262.55.112 MARRÓN
1010001171	262.55.425 ROBLE
1010001172	262.55.710 BLANCO

**UNIÓN ANGULAR PEQUEÑA**

código	descripción
1010001174	262.56.155 MARRÓN
1010001175	262.56.404 ROBLE
1010001176	262.56.708 BLANCO

07 sistemas de unión

HERRAJE UNIÓN 262.61

código	descripción
1010007006	262.61.100 MARRÓN
1010007052	262.61.700 BLANCO

HERRAJE UNIÓN 262.72

código	descripción
1010007072	HERRAJE INFERIOR 262.72.953 NÍQUEL
1010007071	HERRAJE SUPERIOR 262.72.701 NÍQUEL

HERRAJE RASANT-TAD 262.36.510

código	acabado
1010008460	NÍQUEL

HERRAJE UNIÓN 263

código	descripción
1010006805	263.70.534 NÍQUEL
1010006806	263.72.234 BLANCO

TORNILLO UNIÓN A-486-12 M-6 30-42 mm.

código	acabado
1010008694	NÍQUEL

TORNILLO UNIÓN CABEZA ALLEN

código	descripción
1010007101	70119 5x50 mm. ZINCADO
1010007100	70121 7x50 mm. ZINCADO





SOPORTE ESTANTE A-140

código	acabado
1010006508	LATONADO



CASQUILLO A-142 LATONADO

código	acabado
1010007468	LATONADO



SOPORTE 21-B 81140 NÍQUEL

código	acabado
1010005471	NÍQUEL



SOPORTE 81940 NÍQUEL

código	acabado
1010005470	NÍQUEL



SOPORTE 138 80138 NÍQUEL

código	acabado
1010003629	NÍQUEL



SOPORTE 5062910 LATONADO

código	acabado
1010003441	LATONADO



SOPORTE MADERA 21-A 81142

código	acabado
1010005472	NÍQUEL



SOPORTE MADERA 21-C 85141

código	acabado
1010005473	NÍQUEL



SOPORTE MADERA 21-D 81143

código	acabado
1010005474	NÍQUEL



SOPORTE 282.24.710

código	acabado
1010008461	NÍQUEL



SOPORTE 26

código	acabado
1010007193	NÍQUEL
1010007194	BICROMATIZADO



SOPORTE SAFETY A-110

código	acabado
1010006911	A-110-2 BLANCO
1010006529	A-110-22 TRANSPARENTE
1010006910	A-110-8 MARRÓN

08 soportaestantes

SOPORTE A-114-22 5 mm.

código	acabado
1010006370	TRANSPARENTE

SOPORTE GRANDE A-130

código	acabado
1010006482	A-130-2 BLANCO
1010006483	A-130-8 MARRÓN

SOPORTE PEQUEÑO A-132

código	acabado
1010006485	A-132-2 BLANCO
1010006484	A-132-8 MARRÓN

SOPORTE A-129

código	acabado
1010006879	A-129-2 BLANCO
1010006878	A-129-8 MARRÓN

SOPORTE DOS PUNTAS

código	descripción
1010006827	A-100-2 GRANDE BLANCO
1010006826	A-100-8 GRANDE MARRÓN
1010007219	7 PEQUEÑO BLANCO
1010007195	8 PEQUEÑO MARRÓN

09 varios

DESLIZANTE A-302

código	descripción
1010006369	A-302-02 17 mm. BLANCO
1010006494	A-302-8 17 mm. MARRÓN

DESLIZANTE A-312-8

código	acabado
1010007197	MARRÓN

DESLIZANTE FIELTRO

código	descripción
1010008271	3146-4 20 mm.
1010008272	3147-4 24 mm.

DESLIZANTE FIELTRO ADHESIVO 4072-4

código	medidas
1010008273	22x3 mm.

DESLIZANTE FIELTRO ADHESIVO 4075-4

código	medidas
1010008274	22x3 mm.

TOPE PUERTA A-328

código	descripción
1010008075	A-328-2 BLANCO
1010008042	A-328-22 TRANSPARENTE
1010008076	A-328-36 GRIS
1010008074	A-328-6 ROBLE



TOPE LAGRIMA ADHESIVO

código	descripción
1010006858	A-320 7x1'5 mm.
1010006814	A-316 10x3 mm.



CUÑA NIVELADORA A-314-4

código	acabado
1010006861	MARRÓN



NIVELADOR REGULABLE 30168

código	acabado
1010003607	NÍQUEL



NIVELADOR NI60404 M6x25

código	acabado
1010008508	BLANCO



PIVOTE MESA 20286

código	descripción
1010005652	10x12,5 mm. HEMBRA BICROMATIZADO
1010005638	10x12,5 mm. MACHO BICROMATIZADO



CIERRE ALA DE MESA CI299 ZINCADO

código	acabado
1010006778	ZINCADO



ENSAMBLE CAMA 4005

código	acabado
1010000931	BICRO



HERRAJE PARA CAMA ABATIBLE

código	descripción
1010007011	HERRAJE CAMA 271.95.203



HERRAJE PARA CAMA ABATIBLE

código	descripción
1010007012	PISTÓN GAS CAMA 271.99.300

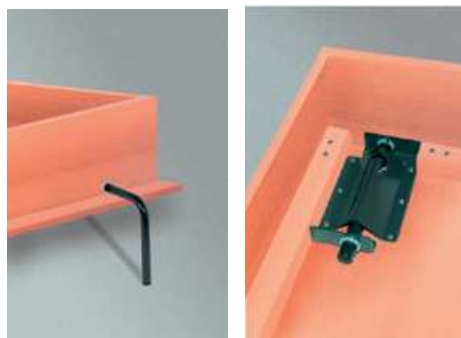

HERRAJE PARA CAMA ABATIBLE

código	descripción
1010007013	PATA PLEGABLE 271.95.361 CAMA
1010008772	PALANCA SEGURIDAD CAMA 271.95.371

09 varios

BISAGRA CANAPÉ 93011

código	descripción
1010007849	710x115 mm. NEGRO

PISTÓN A GAS PARA CANAPÉ

código	descripción
1010007880	PISTÓN GAS CANAPÉ 93012 8000N
1010007848	PISTÓN GAS CANAPÉ 93013 1150N

CUELGAPERCHAS EXTRAIBLE 107.31.0

código	medidas
1010000863	250 mm. NÍQUEL
1010000864	300 mm. NÍQUEL
1010000865	350 mm. NÍQUEL
1010000866	400 mm. NÍQUEL
1010000867	450 mm. NÍQUEL
1010000868	500 mm. NÍQUEL

PERFIL PARA PUERTA FACE

código	descripción
1020008610	PLATA 3200 mm.

TENSOR PUERTA 91145 COMPLETO

código	descripción
1010004104	1920 mm.

PORTATECLADO 41931

código	acabado
1010004520	GRIS

TAPA PASACABLES

código	descripción
1010008073	95004 GRIS
1010007979	95005 NEGRO

SOPORTE TV 4002505 331x325 mm.

código	descripción
1010003121	332x325 mm.

HERRAJE GIRATORIO

código	descripción
1010001149	HERRAJE GIRATORIO 646.12.102
1010001164	RUEDA GIRATORIA 646.11.016

RUEDA EMBUTIR 661.04.318

código	acabado
1010004374	NEGRO

RUEDA GIRATORIA

código	descripción
1010001165	661.02.210 25 mm.
1010001166	661.02.230 35 mm.
1010001167	661.02.250 45 mm.

RUEDA PLETINA

código	descripción
1010008855	3036617 40 mm.
1010008854	3036817 50 mm.



SOPORTE PARED HORIZONTAL 107.56.0

código	acabado
102000051	ZINCADO



COLGADOR 102.56.1

código	acabado
101000858	ZINCADO



ESCUADRA COLGADOR E-116 ZINCADO

código	acabado
1010007878	ZINCADO



COLGADOR 1.

código	descripción
1010000191	40 mm. NÍQUEL
1010000192	50 mm. NÍQUEL
1010000193	60 mm. NÍQUEL
1010000194	70 mm. NÍQUEL
1010000195	80 mm. NÍQUEL



TUERCA EXPANSIÓN 9003402 M-4 LATÓN

código	acabado
1010007969	LATÓN



ARANDELA DENTADA 5099505

código	acabado
1010009120	ZINCADO



TAPATORNILLOS ADHESIVO A-350

código	descripción
1010007226	A-350-38 GRIS METALIZADO
1010006374	A-350-44 HAYA CLARO
1010006346	A-350-46 HAYA VARIA
1010006345	A-350-48 HAYA NATURAL
1010006350	A-350-52 ROBLE CASCOS
1010006755	A-350-60 CEREZO CLARO
1010008262	A-350-L1 LINO CLARO
1010008263	A-350-L3 LINO OSCURO
1010006509	A-350 BEIGE
1010006371	A-350-2 BLANCO

1010006542	A-350-20 NEGRO
1010006344	A-350-32 PINO
1010006348	A-350-34 SAPELLY
1010006373	A-350-36 GRIS
1010008337	A-350-40 CREMA
1010006372	A-350-42 MAPLE
1010006754	A-350-50 TULIPIE
1010006347	A-350-56 NOGAL
1010006478	A-350-58 CEREZO
1010006540	A-350-6 ROBLE
1010006541	A-350-62 BUBINGA
1010006349	A-350-64 WENGUE
1010008755	A-352-2 17 BLANCO



ROLLO DE LED,s

código	descripción
	14.4W/12V 6000K con protección IP65
1010009262	Rollo 1.000mm
1010009263	Rollo 2.000mm
1010009264	Rollo 3.000mm
1010009265	Rollo 4.000mm
	Transformador válido para rollo LED,s:
1010009257	12W
1010009258	24W
1010009259	60W
1010009260	100W



FOCO HALÓGENO F ZIC6 220W

código	descripción
1010008156	CROMO MATE
1010008155	CROMO BRILLO
	Transformador válido para estos focos:
1010008160	TRANSFORMADOR TR-60W
1010007155	TRANSFORMADOR TR-105W

10 tiradores

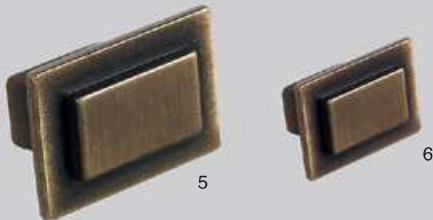
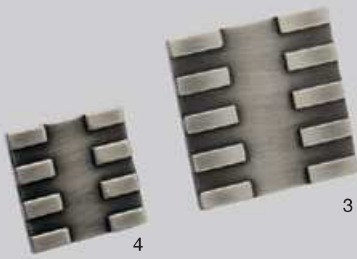
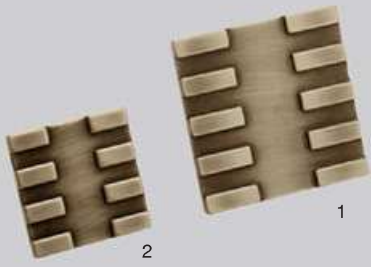



14



15

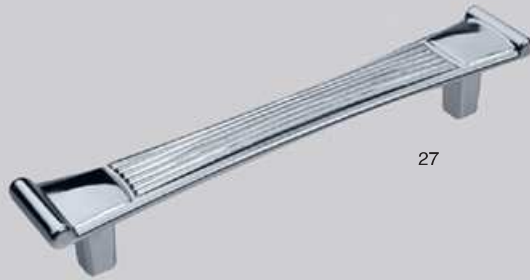

27



18



16



17



19



20



23



24



21



22



25



26

10 tiradores





43



44



45



53



54



55



46



47



56

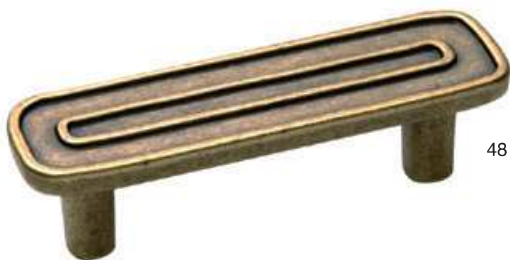

48



57



58



49



50



51



52

10 tiradores



59



60



61



62



63



64



65



66



67

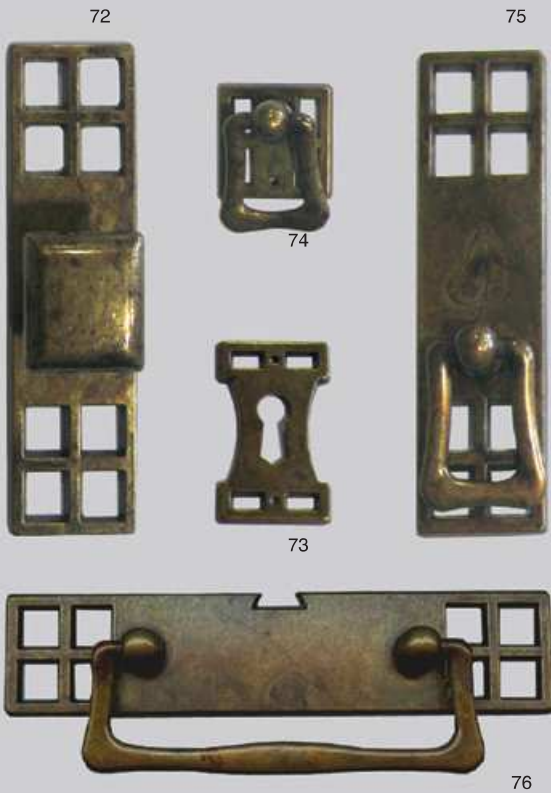
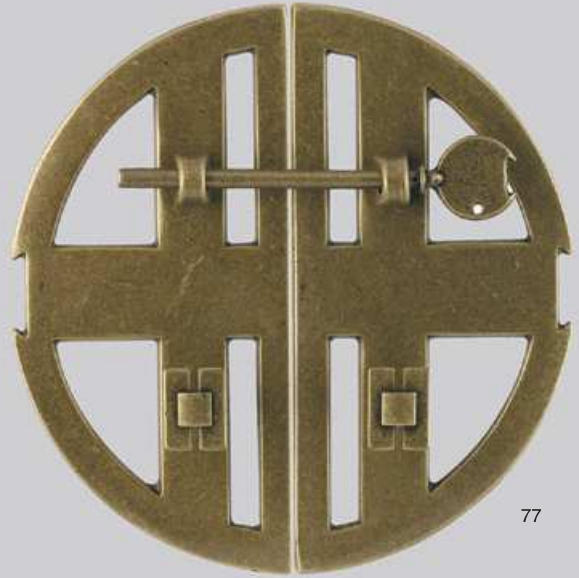
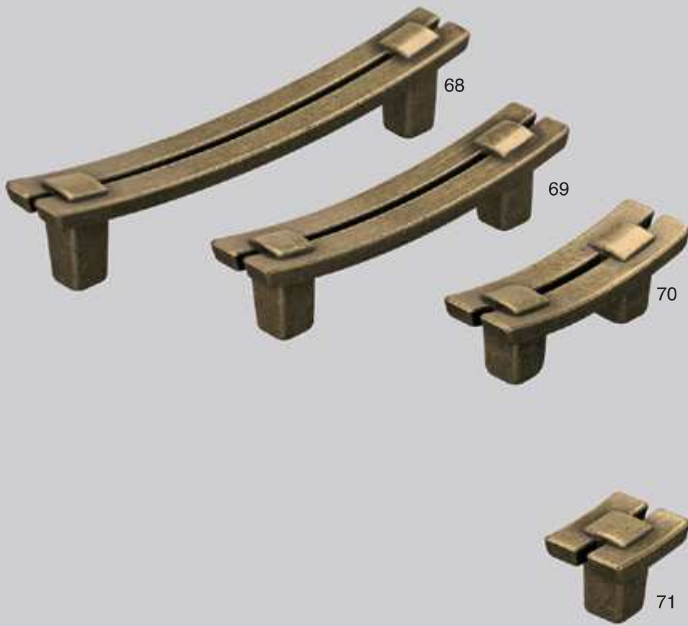

10 tiradores





10 tiradores





118



128



130



119



129



120



127



121



124



125



123



126



122

10 tiradores



131



134



136



135



139



137



133



138



263



149



148



150



152



143



151



142



144



145



146



147



154



141



153

10 tiradores





10 tiradores



181



182



183



180



184



185



187



186



188



189



190



191



192



195



194



193



197



198



199



196



200

10 tiradores



201



202



203



204



209



205



206



207



208



210



211



212



213



214



215



216



217



218



219



222



223



224



227



226



220



221



225



231



232



228



229



234



230



179



233



178



237



236



235

10 tiradores



238



239



240



241



242



243



244



245



246



247



248



249



250



251



252



253



254



255



256



257



258



259



260



261



262

Tiradores

Nº	CÓDIGO	MEDIDAS	ACABADO	PAG.
1	1010008469	50x50 mm.	CUERO	121
2	1010008470	50x50 mm.	PLATA	121
3	1010008471	35x35 mm.	CUERO	121
4	1010008472	35x35 mm.	PLATA	121
5	1010008478	37x26 mm.	CUERO	121
6	1010008479	25x18 mm.	CUERO	121
7	1010008467	96 mm.	CUERO	121
8	1010008468	96 mm.	PLATA	121
9	1010008473	128 mm.	CUERO	121
10	1010008474	128 mm.	PLATA	121
11	1010008477	96 mm.	CUERO	121
12	1010007361	15x15 mm.	FLORENCIA	121
12	1010007362	15x15 mm.	NIQUEL BRILLO	121
13	1010007363	27x27 mm.	FLORENCIA	121
13	1010007364	27x27 mm.	NIQUEL BRILLO	121
14	1010005266	166x32 mm. - 128 mm.	FLORENCIA	122
14	1010005265	198x32 mm. - 160 mm.	FLORENCIA	122
15	1010005269	50x19 mm.	FLORENCIA	122
16	1010009012	128 mm.	NIQUEL BRILLO	122
16	1010008030	128 mm.	FLORENCIA	122
17	1010008031	64 mm.	FLORENCIA	122
18	1010007313	72x42 mm.	NIQUEL SATINADO	122
18	1010007314	72x42 mm.	LATON SATINADO	122
18	1010007315	72x42 mm.	CUERO	122
19	1010008481	64 mm. - Ø78 mm.	CROMO BRILLO	122
20	1010008483	32 mm. - Ø41 mm.	CROMO BRILLO	122
21	1010008480	64 mm. - Ø78 mm.	CUERO	122
22	1010008482	32 mm. - Ø41 mm.	CUERO	122
23	1010008485	43x43 mm. - 32 mm.	CROMO BRILLO	122
24	1010008484	43x43 mm. - 32 mm.	CUERO	122
25	1010008475	96 mm.	CUERO	122
26	1010008475	64 mm.	CUERO	122
27	1010008039	131x26 mm. - 96 mm.	CROMO BRILLO	122
27	1010008038	163x27 mm. - 128 mm.	CROMO BRILLO	122
28	1010008486	50x50 mm.	CUERO	123
29	1010008487	35x35 mm.	CUERO	123
30	1010008488	21x21 mm.	CUERO	123
31	1010009600	25x25 mm.	CUERO	123
32	1010009601	40x40 mm.	CUERO	123
33	1010009602	60x60 mm.	CUERO	123
34	1010009603	40x40 mm.	CUERO DECORADO	123
35	1010009604	50x50 mm.	CUERO DECORADO	123
36	1010009605	60x60 mm.	CUERO DECORADO	123
37	1010008489	40x40 mm.	CUERO	123
38	1010008491	50x50 mm.	CUERO	123
39	1010008493	68x68 mm.	CUERO	123
40	1010008490	40x40 mm.	PLATA	123
41	1010008492	50x50 mm.	PLATA	123
42	1010008494	68x68 mm.	PLATA	123
43	1010008029	123x34 mm. - 96 mm.	FLORENCIA	124

Tiradores

Nº	CÓDIGO	MEDIDAS	ACABADO	PAG.
43	1010008037	160x29 mm. - 128 mm.	Florenzia	124
44	1010007063	128 mm.	BRONCE RÚSTICO	124
45	1010007483	128 mm.	BRONCE RÚSTICO	124
46	1010009342	96 mm.	BRONCE RÚSTICO	124
46	1010009343	96 mm.	ESTAÑO RÚSTICO	124
47	1010009340	96 mm.	BRONCE RÚSTICO	124
48	1010008033	96 mm.	FLORENCIA	124
48	1010008034	64 mm.	FLORENCIA	124
49	1010009351	22 mm.	BRONCE RÚSTICO	124
50	1010008028	Ø30 mm.	FLORENCIA	124
51	1010004381	Ø30 mm.	FLORENCIA	124
52	1010007482	60X24 mm.	BRONCE RÚSTICO	124
53	1010004462	128 mm.	FLORENCIA	124
54	1010009606	96 mm.	FLORENCIA	124
55	1010008025	128 mm.	FLORENCIA	124
55	1010008026	96 mm.	FLORENCIA	124
55	1010008027	64 mm.	FLORENCIA	124
56	1010009341	96 mm.	BRONCE RÚSTICO	124
57	1010008035	32 mm.	FLORENCIA	124
58	1010008036	30x30 mm.	FLORENCIA	124
59	1010009607	110 mm. - 96 mm.	GRIS	125
60	1010009608	110 mm. - 96 mm.	CUERO	125
61	1010009609	22x20 mm.	CUERO	125
62	1010009610	16x16 mm.	CUERO	125
63	1010009611	19x20 mm.	CUERO	125
64	1010007523	210x160 mm.	LATÓN RÚSTICO	125
65	1010007524	210x160 mm.	PLATA RÚSTICA	125
66	1010003541	125 mm. - 96 mm.	CUERO	125
67	1010003542	90 mm. - 64 mm.	CUERO	125
68	1010007146	152 mm. - 128 mm.	FLORENCIA	126
69	1010005816	120 mm. - 96 mm.	FLORENCIA	126
70	1010005815	88 mm. - 64 mm.	FLORENCIA	126
71	1010005814	55 mm. - 32 mm.	FLORENCIA	126
72	1010005823	28x95 mm.	ENV.MANCHAS	126
73	1010005822	22x48 mm.	ENV.MANCHAS	126
74	1010005821	29x39 mm.	ENV.MANCHAS	126
75	1010005820	29x95 mm.	ENV.MANCHAS	126
76	1010005819	130x29 mm.	ENV.MANCHAS	126
77	1010005818	Ø168 mm.	FLORENCIA	126
78	1010005824	Ø168 mm.	ENV.MANCHAS	126
79	1010009612	121x35 mm. - 96 mm.	PLATA VIEJA	127
80	1010009613	121x35 mm. - 96 mm.	CUERO DECORADO	127
81	1010009614	121x35 mm. - 96 mm.	CUERO	127
82	1010009615	60x35 mm. - 22 mm.	PLATA VIEJA	127
83	1010009616	60x35 mm. - 22 mm.	CUERO	127
84	1010009617	30x35 mm.	CUERO	127
85	1010009618	100x15 mm. - 64 mm.	CUERO	127
86	1010009619	135x16 mm. - 96 mm.	CUERO	127
87	1010009620	135x36 mm. - 96 mm.	GRIS	127
88	1010009621	84x15 mm. - 32 mm.	GRIS	127

Tiradores

Nº	CÓDIGO	MEDIDAS	ACABADO	PAG.
89	1010009622	84x15 mm. -32 mm.	CUERO DECOR	127
90	1010009623	84x15 mm. -32 mm.	CUERO	127
91	1010009624	44x8 mm. - 32	CUERO	128
92	1010009625	75x8 mm. - 64 mm.	CUERO	128
93	1010009626	104x8 mm. - 96 mm.	GRIS	128
94	1010009627	132x8 mm. - 128 mm.	CUERO	128
95	1010009628	168x8 mm. - 160 mm.	CUEO	128
96	1010009629	65x8 mm. - 32 mm.	CUERO	128
97	1010009630	104x8 mm. - 64 mm.	GRIS	128
98	1010009631	104x8 mm. - 64 mm.	CUERO	128
99	1010009632	132x8 - 96 mm.	CUERO	128
100	1010009633	165x8 mm. - 128 mm.	CUERO	128
101	1010009634	85x43 mm.	CUERO	129
102	1010009635	85x43 mm.	PLATA VIEJA	129
103	1010009636	67x40 mm.	CUERO	129
104	1010009637	85x43 mm.	NEGRO	129
105	1010009638	75x42 mm.	CUERO	129
106	1010009639	67x40 mm.	CROMO MATE	129
107	1010009640	84x30 mm. - 64 mm.	CUERO	129
108	1010009641	84x30 mm. - 64 mm.	CHAMPAGNE	129
109	1010009642	84x30 mm. - 64 mm.	GRIS	129
110	1010004021	85x64 mm.	CROMO MATE	129
111	1010002172	50x32 mm.	CROMO MATE	129
112	1010002175	76x64 mm.	CUERO	129
113	1010004380	91x47 mm. - 32 mm.	ENV. ANTIGUO	129
114	1010005043	72x26 mm. - 64 mm.	ENV.MANCHAS	129
115	1010004379	97x52 mm. - 64 mm.	ENV.ANTIGUO	129
116	1010005270	102x34 mm. - 64 mm.	FLORENCIA	129
117	1020004184	74x31 mm. - 64 mm.	FLORENCIA	129
118	1010005017	97x33 mm.	ENV.MANCHAS	130
119	1010005706	109x39 mm.	FLORENCIA	130
120	1010005690	109x39 mm. - 64 mm.	FLORENCIA	130
121	1010003362	100x43 mm.	ENV.MANCHAS	130
122	1010003363	80x35 mm.	ENV.MANCHAS	130
123	1010003367	80x35 mm.	ENV.MANCHAS	130
124	1010003364	100x43 mm. - 64 mm.	ENV.MANCHAS	130
125	1010003368	25x88 mm.	ENV.MANCHAS	130
126	1010003365	80x35 mm.- 48 mm.	ENV.MANCHAS	130
127	1010005703	33x97 mm.	FLORENCIA	130
128	1010005709	43x25 mm.	FLORENCIA	130
129	1010005708	25x43 mm.	FLORENCIA	130
130	1010005705	35x32 mm.	FLORENCIA	130
131	1010005039	35x33 mm.	ENV.MANCHAS	131
132	1010009643	97x33 mm.	ENV.MANCHAS	131
133	1010002179	30x45 mm.	CUERO	131
134	1010002181	95x35 mm.	CUERO	131
135	1010002182	95x35 mm.	CUERO	131
134	1010002177	95x35 mm.	CUERO	131
137	1010002178	45x30 mm.	CUERO	131
138	1010005040	33x97 mm.	PLATA ANTIGUA	131

Tiradores

Nº	CÓDIGO	MEDIDAS	ACABADO	PAG.
139	1010005038	33x97 mm.	PLATA ANTIGUA	131
140	1010009644	33x97 mm.	ENV.MANCHAS	131
141	1010005031	42x49 mm.	ENV.MANCHAS	132
142	1010005020	38x114 mm.	ENV.MANCHAS	132
143	1010005019	89x42 - 64 mm.	ENV.MANCHAS	132
144	1010005018	114x38 mm. - 64 mm.	ENV.MANCHAS	132
145	1010005022	114x38 mm.	ENV.MANCHAS	132
146	1010005140	22x71 mm.	ENV.MANCHAS	132
147	1010008026	126x53 mm. - 96 mm.	ENV, MANCHA	132
148	1010003232	120x32 mm.	CUERO	132
149	1010003070	120x25 mm.	CUERO	132
150	1010003069	60 mm.	CUERO	132
151	1010003346	80x64 mm.	CUERO	132
152	1010003068	40 mm.	CUERO	132
153	1010005033	47x52 mm.	ENV, MANCHA	132
154	1010005045	50 mm.	PLATA VIEJA	132
155	1010004001	22x114 mm.	CUERO	133
155	1010004002	22x114 mm. C/B	CUERO	133
156	1010004000	29x154 mm.	CUERO	133
156	1010003999	29x154 mm. C/B	CUERO	133
157	1010003996	27x165 mm.	CUERO	133
157	1010003995	27x165 mm. C/B	CUERO	133
158	1010003997	21x123 mm.	CUERO	133
158	1010003998	21x123 mm. C/B	CUERO	133
159	1010004004	21x55 mm.	CUERO	133
160	1010004005	32 mm. - 38x70 mm.	CUERO	133
161	1010004006	32 mm. - 32x79 mm.	CUERO	133
162	1010004007	64 mm. - 34x79 mm.	CUERO	133
163	1010008692	Sin Bocallave	CUERO	134
163	1010007732	Con Bocallave	CUERO	134
164	1010007023	Sin Bocallave	CUERO	134
164	1010007047	Con Bocallave	CUERO	134
165	1010002024	Sin Bocallave	CUERO	134
165	1010002012	Con Bocallave	CUERO	134
166	1010004020	-	CUERO	134
167	1010007031	-	CUERO	134
168	1010006976	-	CUERO	134
169	1010007238	45x79 mm.	CUERO	134
170	1010008790	39x55 mm.	CUERO	134
171	1010009645	45x79 mm.	CUERO DECORADO	134
172	1010009646	45x32 mm.	CUERO	134
173	1010007066	25x121 mm.	CUERO	134
174	1010009647	45x27 mm.	CUERO	134
175	1010009648	50x30 mm.	CUERO	134
176	1010009649	45x32 mm.	CUERO	134
177	1010009650	31x165 mm.	CUERO	134
178	1010009651	Ø27 mm.	NEGRO	138
179	1010005850	34x34 mm.	ESTAÑO RÚSTICO	138
180	1010009652	-	CUERO	135
181	1010008053	96 mm.	CUERO	135

Tiradores

Nº	CÓDIGO	MEDIDAS	ACABADO	PAG.
182	1010007927	64 mm.	CUERO	135
183	1010009653	64 mm.	CUERO	135
184	1010009654	-	CUERO	135
185	1010004183	58 mm.	FLORENCIA	135
186	1010004180	120x52 mm. - 96 mm.	FLORENCIA	135
187	1010004182	82x35 mm. - 64 mm.	FLORENCIA	135
188	1010000924	29x115 mm.	CUERO	136
189	1010002991	29x115 mm.	CUERO	136
190	1010000948	29x155 mm.	CUERO	136
191	1010000917	115x29 mm.	CUERO	136
192	1010009655	115x29 mm.	CUERO	136
193	1010000452	C/B 29x174 mm.	CUERO	136
193	1010000462	29x174 mm.	CUERO	136
194	1010000453	C/B 24x108 mm.	CUERO	136
194	1010000463	24x108 mm.	CUERO	136
195	1010000428	23x106 mm.	CUERO	136
196	1010000439	46x88 mm. - 64 mm.	CUERO	136
197	1010000419	23x65 mm.	CUERO	136
198	1010004018	16x51 mm.	CUERO	136
199	1010004017	45x119 mm. - 96 mm.	CUERO	136
200	1010000436	37x86 mm. - 64 mm.	CUERO	136
201	1010000438	40x84 mm. - 64 mm.	CUERO	137
202	1010000435	27x82 mm.	CUERO	137
203	1010000431	C/B 26x107 mm.	CUERO	137
203	1010000433	26x107 mm.	CUERO	137
204	1010000430	C/B 30x160 mm.	CUERO	137
204	1010000432	30x160 mm.	CUERO	137
205	1010000437	46x155 mm. - 96 mm.	CUERO	137
206	1010000442	40x90 mm. - 64 mm.	CUERO	137
207	1010000441	52x123 mm. - 96 mm.	CUERO	137
208	1010003272	52x82 mm.	CUERO	137
209	1010000429	26x48 mm.	CUERO	137
210	1010007084	Con Bocallave	CUERO	137
210	1010007048	-	CUERO	
211	1010007085	Con Bocallave	CUERO	137
211	1010007022	-	CUERO	
212	1010006974	-	CUERO	137
213	1010006975	-	CUERO	137
214	1010007174	-	CUERO	137
215	1010009656	17x35 mm.	GRIS PLATA	138
216	1010009657	17x35 mm.	CUERO	138
217	1010007642	22x22 mm.	CUERO	138
218	1010007641	22x22 mm.	PLATA VIEJA	138
219	1010007487	40 mm.	NIQUEL SATINADO	138
220	1020007197	Ø25 mm.	NIQUEL SATINADO	138
220	1020007198	Ø30 mm.	NIQUEL SATINADO	138
221	1020008122	Ø25 mm.	BRONCE	138
221	1020008123	Ø30 mm.	BRONCE	138
222	1010009658	20x30 mm.	CUERO	138

Tiradores

Nº	CÓDIGO	MEDIDAS	ACABADO	PAG.
223	1010009659	Ø20 mm.	CUERO	138
224	1010005015	Ø24 mm.	CUERO	138
224	1010009660	Ø24 mm.	NEGRO	138
224	1010009661	Ø24 mm.	CROMO BRILLO	138
224	1010009662	Ø24 mm.	NIQUEL SAINADO	138
225	1010001457	Ø35 mm.	CUERO	138
226	1010007069	25x25 mm.	CUERO	138
226	1010009663	25x25 mm.	CHAMPAGNE	138
226	1010006946	25x25 mm.	GRIS PLATA	138
227	1010007216	25x25 mm.	CUERO	138
227	1010007105	25x25 mm.	GRIS PLATA	138
228	1010004791	32x32 mm.	NIQUEL SATINADO	138
229	1010009664	24x24 mm.	CROMO BRILLO	138
230	1010007467	40x40 mm.	BRONCE RÚSTICO	138
231	1010005368	Ø30 mm.	BRONCE RÚSTICO	138
231	1010005367	Ø30 mm.	ESTAÑO RÚSTICO	138
232	1010007064	Ø34 mm.	BRONCE RÚSTICO	138
233	1010004833	12x12 mm.	CROMO BRILLO	138
233	1010004877	12x12 mm.	NIQUEL SATINADO	138
234	1010004977	37x25 mm.	NIQUEL SATINADO	138
235	1010007466	60 mm.	BRONCE RÚSTICO	138
236	1010000951	Ø33 mm.	CUERO	138
237	1010000950	Ø27 mm.	CUERO	138
238	1010005720	Ø36 mm.	CENICIENTA	139
239	1010005721	Ø36 mm.	BLANCANIEVES	139
240	1010006431	37x42 mm.	MAGENTA	139
241	1010006427	37x42 mm.	MAGENTA	139
242	1010006439	Ø36 mm.	VERDE	139
243	1010005219	40 mm.	PIGLET	139
244	1010005718	43 mm.	TIGGER	139
245	1010005716	30 mm.	POOH	139
246	1010005710	39 mm.	MICKY	139
247	1010006416	42x40 mm.	ROJO/BLANCO	139
248	1010006444	70x67 mm.	AMARILLO	139
249	1010006441	70x55 mm.	AZUL	139
250	1010006420	44x48 mm.	GOMA	139
251	1010006418	Ø42 mm.	GOMA	139
252	1010006466	47x45 mm.	NARANJA/MAGENTA	139
253	1010004170	40x33 mm.	ROSA	139
254	1010004168	34x40 mm.	AZUL	139
255	1010006434	43x38 mm.	MIEL	139
256	1010004174	Ø35 mm.	ROSA	139
257	1010004181	44x30 mm.	AMARILLO	139
258	1010006411	32x32 mm.	CERAMICA WENGUÉ	139
259	1010006458	40x40 mm.	HAYA	139
260	1010006452	Ø44 mm.	AMARILLO	139
261	1010006463	Ø43 mm.	VERDE	139
262	1010006422	Ø37 mm.	MAGENTA/AZUL	139
263	1010003067	159x28 mm.	MAGENTA/AZUL	139



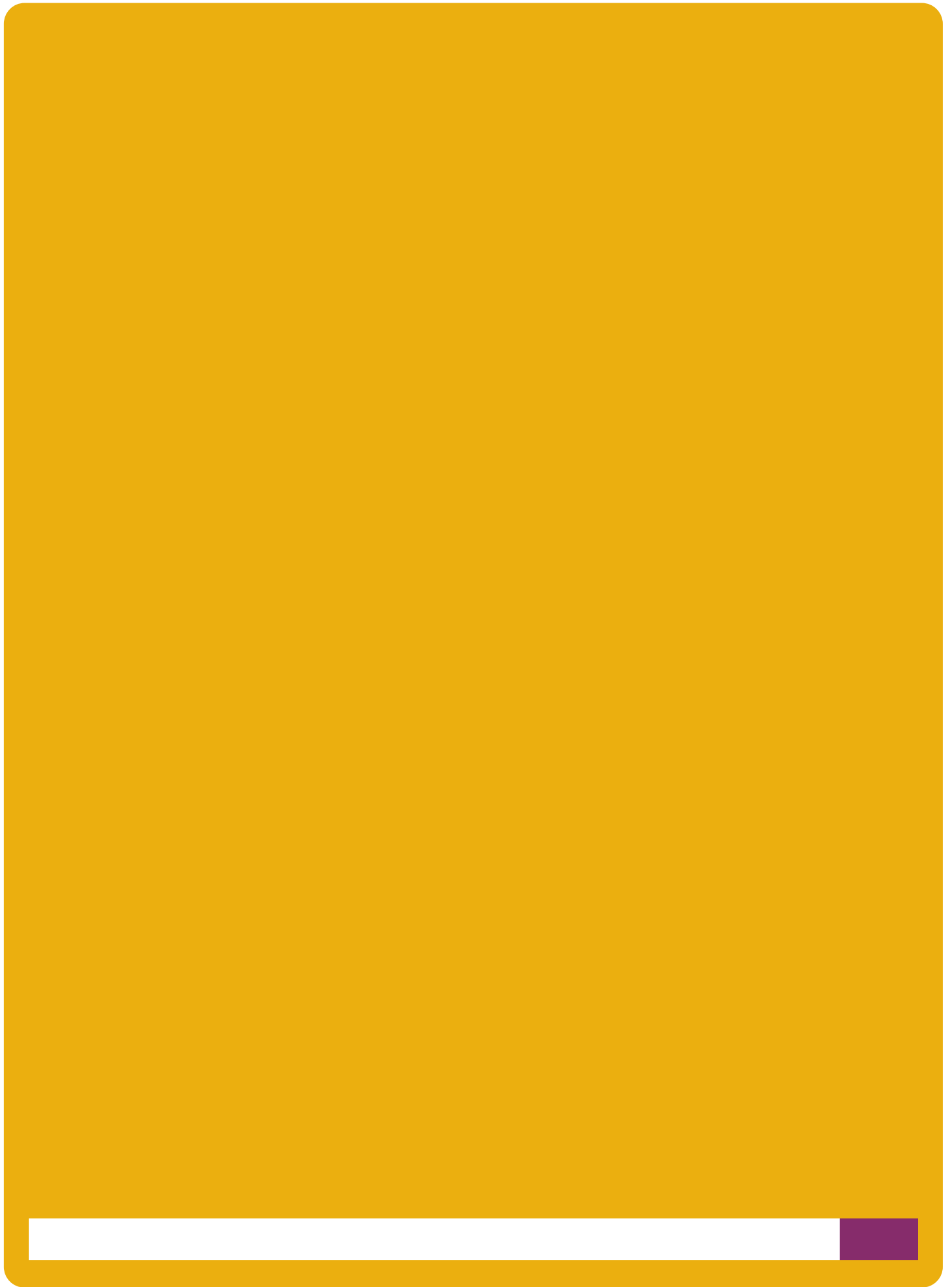

IG4

sistemas para armarios

01 herrajes de interior

146

02 perfiles de aluminio

148

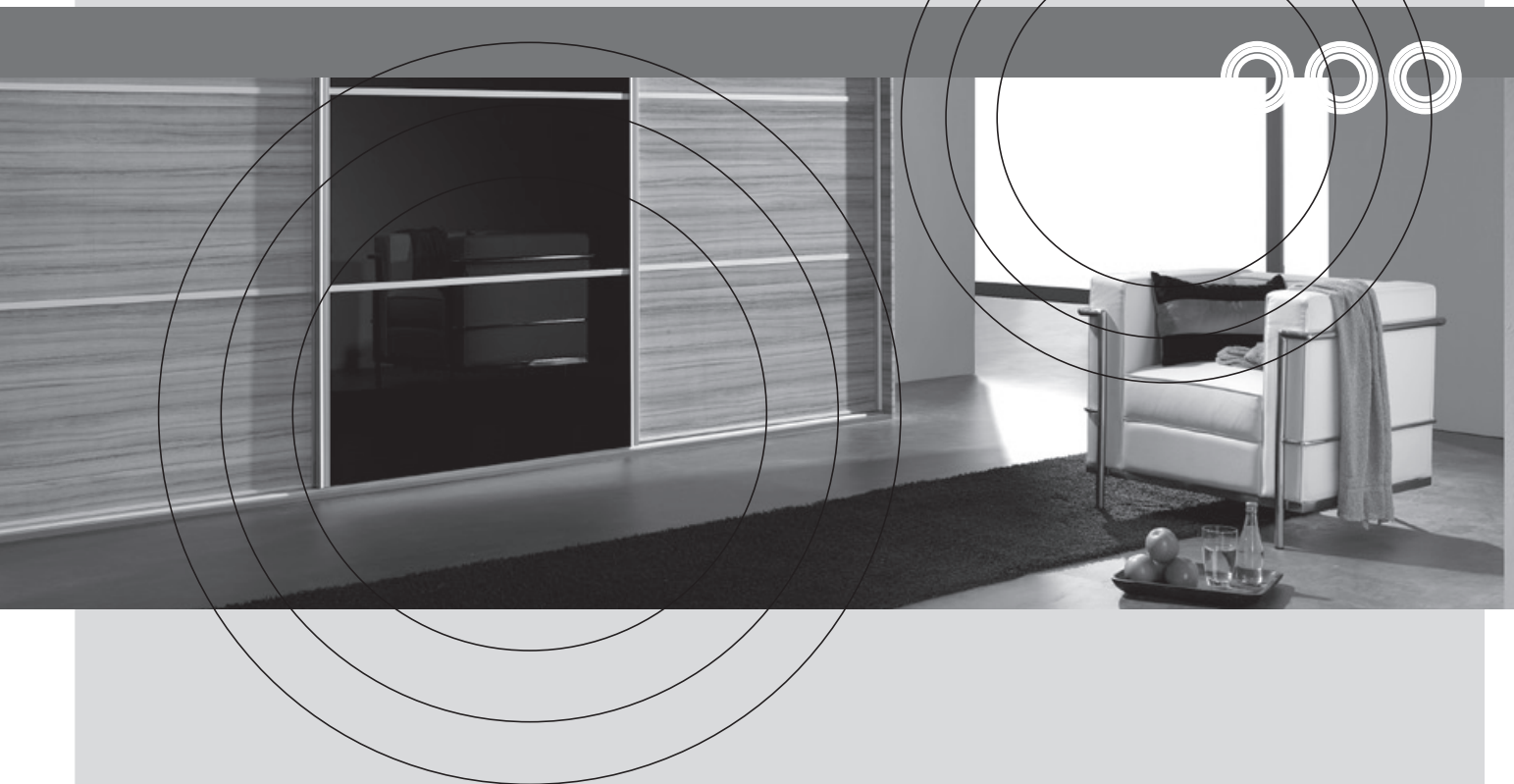



PERCHERO ABATIBLE 103HP		PERCHERO ABATIBLE CON FRENO 107HP		ESPEJO EXTRAÍBLE	
código	descripción	código	descripción	código	descripción
1010007835	450-600 mm. PLATA	1010009374	830-1150 mm. CROMO BRILLO	1010008369	246HP 1200X400 mm. PLATA
1010007825	600-830 mm. PLATA			1010006519	420940 1045X480 mm. PLATA
1010007801	830-1150 mm. PLATA			1010006523	420930 605X480 mm. PLATA



PANTALONERO EXTRAÍBLE 11 GANCHOS		PANTALONERO EXTRAÍBLE REFORZADO		PANTALONERO DOBLE 22 GANCHOS	
código	descripción	código	descripción	código	descripción
1010007432	330x465x110 mm. CROMO BRILLO	1010009201	350x470x100 mm. CROMO BRILLO	1010008525	257HP CON FOAM 480x650x150 mm. CROMO B.
				1010008526	258HP SIN FOAM 480x650x150 mm. CROMO B.



PANTALONERO MULTIFUNCIÓN		PANTALONERO COMPACTO		PANTALONERO ROTATIVO	
código	descripción	código	descripción	código	descripción
	Marco extensible has 60 mm. más en anchura guías de extracción total con freno.		Marco extensible has 60 mm. más en anchura guías de extracción total con freno.		
1010008521	246HP 764x465x80 mm. PLATA	1010008514	243HP 9 Ganchos 664x465x63 mm. PLATA	1010008527	259HP con FOAM 430X430X100 mm.
1010008522	247HP 864x465x80 mm. PLATA	1010008515	244HP 11 Ganchos 764x465x63 mm. PLATA		
		1010008516	245HP 13 Ganchos 864x465x63 mm. PLATA		

01 herrajes de interior

PANTALONERO LATERAL

código	descripción
1010008528	261HP con FOAM 460x360 mm. CROMO B.
1010008529	262HP sin FOAM 460x360 mm.

ZAPATERO EXTENSIBLE EXTRAIBLE

código	descripción
1010007922	450-600mm CROMO BRILLO
1010007906	550-800mm CROMO BRILLO
1010007901	640-1000mm CROMO BRILLO

CESTO EXTRAIBLE

código	descripción
	GUÍAs de extracción total
1010008518	248HP 564x465x140 mm. PLATA
1010008519	249HP 764x465x140 mm. PLATA
1010008520	250HP 864x465x140 mm. PLATA
1010008635	305HP 964x465x140 mm. PLATA

ZAPATERO LATERAL CROMO BRILLO

código	descripción
	Guías de extracción total con freno
1010008523	253HP 2 BANDEJAS 305X465X440 mm.
1010008524	254HP 3BANDEJAS 305X465X630 mm.

PLANCHADOR

código	descripción
1010008534	295x800x106 mm.

CORBATERO EXTRAÍBLE

código	descripción
1010007802	65x450x81 mm. PLATA

TUBO OVALADO ALUMINIO

código	descripción
1020009007	PLATA 30x15x4000 mm.
1010006753	ORO 30x15x4000 mm.

UBO OVALADO RINCON 90°

código	descripción
1010008571	PLATA 30X15X1015 mm.

SOPORTE TUBO LATERAL

código	descripción
1010006924	ORO 30x15 mm.
1010006800	NIQUEL 30x15 mm.
1010006891	PLATA 30x15 mm.

SOPORTE TUBO CENTRAL

código	descripción
1010006923	ORO 30x15 mm.
1010006813	NIQUEL 30x15 mm.
1010006892	PLATA 30x15 mm.
1010008081	PLATA CON TAPA 30x15 mm.



KIT PUERTA FO-16

Para tablero de 16 mm.

El kit incluye:
 2 Perfil Tirador 2600 mm. con cepillo
 1 Perfil U 1000 mm
 2 Rueda Inferior 60 mm.
 2 Rueda Superior

código	acabado
1020009505	PLATA MATE
1020009535	BLANCO
1020009536	RECHAPADO HAYA
1020009506	RECHAPADO PINO
1020009571	RECHAPADO ROBLE
1020009518	MELAMINA BLANCO BARNIZADO
1020009567	MELAMINA CEREZO
1020009648	MELAMINA WENGUÉ



KIT GUÍAS GSO-GI70

código	acabado
1020009507	2000 mm. PLATA MATE
1020009537	2000 mm. BLANCO
1020009540	2000 mm. RECHAPADO HAYA
1020009510	2000 mm. RECHAPADO PINO
1020009572	2000 mm. RECHAPADO ROBLE
1020009519	2000 mm. MELAMINA BLANCO BARNIZADO
1020009568	2000 mm. MELAMINA CEREZO
1020009649	2000 mm. MELAMINA WENGUÉ
1020009508	3000 mm. PLATA MATE
1020009538	3000 mm. BLANCO
1020009541	3000 mm. RECHAPADO HAYA
1020009511	3000 mm. RECHAPADO PINO
1020009573	3000 mm. RECHAPADO ROBLE
1020009520	3000 mm. MELAMINA BLANCO BARNIZADO
1020009569	3000 mm. MELAMINA CEREZO
1020009650	3000 mm. MELAMINA WENGUÉ

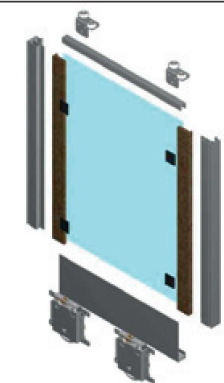

KIT PUERTA MINVH10

Para tablero de 10 mm.

El kit incluye:
 2 Perfil Tirador 2600mm. con cepillo
 1 Perfil U 1000mm
 2 Rueda Inferior 60mm
 2 Rueda Superior

código	acabado
1020009565	PLATA MATE

PERFIL H-16

Medidas: 16x3000 mm.

código	acabado
1020009513	PLATA MATE
1020009544	BLANCO
1020009545	RECHAPADO HAYA
1020009514	RECHAPADO PINO
1020009600	RECHAPADO ROBLE
1020009516	MELAMINA BLANCO BARNIZADO
1020009596	MELAMINA CEREZO
1020009655	MELAMINA WENGUÉ

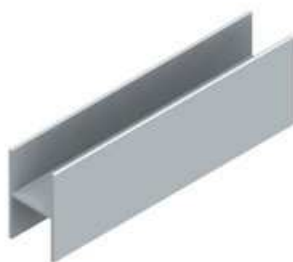

1020009509	4000 mm. PLATA MATE
1020009539	4000 mm. BLANCO
1020009542	4000 mm. RECHAPADO HAYA
1020009512	4000 mm. RECHAPADO PINO
1020009574	4000 mm. RECHAPADO ROBLE
1020009521	4000 mm. MELAMINA BLANCO BARNIZADO
1020009570	4000 mm. MELAMINA CEREZO
1020009653	4000 mm. MELAMINA WENGUÉ



PERFIL H-10

Medidas: 10x3000 mm.

código	acabado
1020009594	PLATA MATE



PERFIL U-16

Medidas: 16x3000 mm.

código	acabado
1020009660	BLANCO
1020009581	RECHAPADO PINO
1020009580	PLATA MATE



PERFIL U-10

Medidas: 10x3000 mm.

código	acabado
1020009661	PLATA MATE





José Santiago Vargas, s.a.
maquinaria y ferretería

Ctra. Córdoba-Málaga, Km. 73'450

Apartado Correos, 91

Tfno. **957 50 10 10** (8 líneas) / Fax 957 50 21 26

14900 LUCENA (Córdoba) - ESPAÑA

